

Surname	Centre Number	Candidate Number
Other Names		0

**GCSE**

4493/01



S16-4493-01

**CHEMISTRY****CHEMISTRY 3  
FOUNDATION TIER**

A.M. THURSDAY, 19 May 2016

1 hour

For Examiner's use only		
Question	Maximum Mark	Mark Awarded
1.	6	
2.	4	
3.	7	
4.	7	
5.	7	
6.	5	
7.	8	
8.	7	
9.	9	
<b>Total</b>	<b>60</b>	

4493  
010001**ADDITIONAL MATERIALS**

In addition to this paper you will need a calculator and a ruler.

**INSTRUCTIONS TO CANDIDATES**

Use black ink or black ball-point pen.

Write your name, centre number and candidate number in the spaces at the top of this page.

Answer **all** questions.

Write your answers in the spaces provided in this booklet.

**INFORMATION FOR CANDIDATES**

The number of marks is given in brackets at the end of each question or part-question.

You are reminded of the necessity for good English and orderly presentation in your answers.

Assessment will take into account the quality of written communication (QWC) used in your answer to question **9(a)**.

The Periodic Table is printed on the back cover of the examination paper and the formulae for some common ions on the inside of the back cover.

Answer **all** questions.

Examiner  
only

1. (a) (i) Balance the symbol equation for the combustion of ethanol. [1]

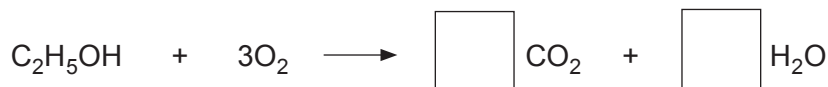

- (ii) Where does the oxygen come from when ethanol is burned? [1]

.....

- (b) Ethanol can be used as a fuel. State **one** other use of ethanol. [1]

.....

- (c) When a student heated some ethanol in a beaker using a Bunsen burner, the ethanol caught fire.

Suggest how a teacher would put out the flame. Explain how the chosen method works. [3]

.....  
.....  
.....  
.....

6

2. The following table shows the names and formulae of some organic compounds.

Name	Formula	Structural formula
ethane	$C_2H_6$	<pre>       H   H                 H—C—C—H                   H   H           </pre>
propane	$C_3H_8$	
propene	$C_3H_6$	<pre>       H   H   H               / \     H—C—C=C   H                   \       H           H           </pre>
propanol		<pre>       H   H   H                     H—C—C—C—O—H                       H   H   H           </pre>
ethene	$C_2H_4$	

(a) Complete the table.

[3]

(b) Name the **two** compounds in the table which are alkenes.

[1]

..... and .....

3. (a) The following pie chart shows the main uses of sulfuric acid in a developing country.

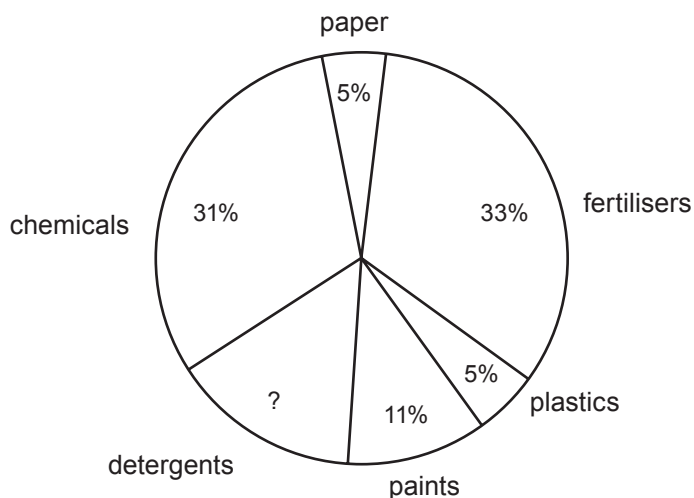

(i) Calculate the percentage of sulfuric acid used to make detergents. [2]

Percentage = ..... %

(ii) In this country, 200 000 tonnes of sulfuric acid are used each year. Calculate the mass of sulfuric acid used each year to make fertilisers. [2]

Mass of sulfuric acid = ..... tonnes

(b) (i) State what is observed when magnesium reacts with sulfuric acid. [1]

.....

(ii) Explain how magnesium could be used to distinguish between sulfuric acid and ethanoic acid. [2]

.....

.....

.....

4. (a) The following table contains the names and formulae of four nitrogenous fertilisers.

Name	Formula
ammonia	$\text{NH}_3$
ammonium sulfate	$(\text{NH}_4)_2\text{SO}_4$
potassium nitrate	$\text{KNO}_3$
urea	$\text{CO}(\text{NH}_2)_2$

Use the information in the table to answer parts (i) and (ii).

- (i) Give the names of **all** the elements present in urea. [1]

- .....
- (ii) Give the name of the compound with the formula  $\text{NH}_4\text{NO}_3$ . [1]

.....

- (b) State why it is an advantage for a fertiliser to release its nitrogen slowly. [1]

.....

- (c) Describe **two** consequences of nitrogenous fertilisers being washed into rivers. [3]

.....

.....

.....

.....

.....

- (d) Another substance which is added to soil by farmers is calcium hydroxide, commonly known as slaked lime.

Give the reason why slaked lime is added to soil. [1]

.....

5. The following key shows how to identify some negative ions.

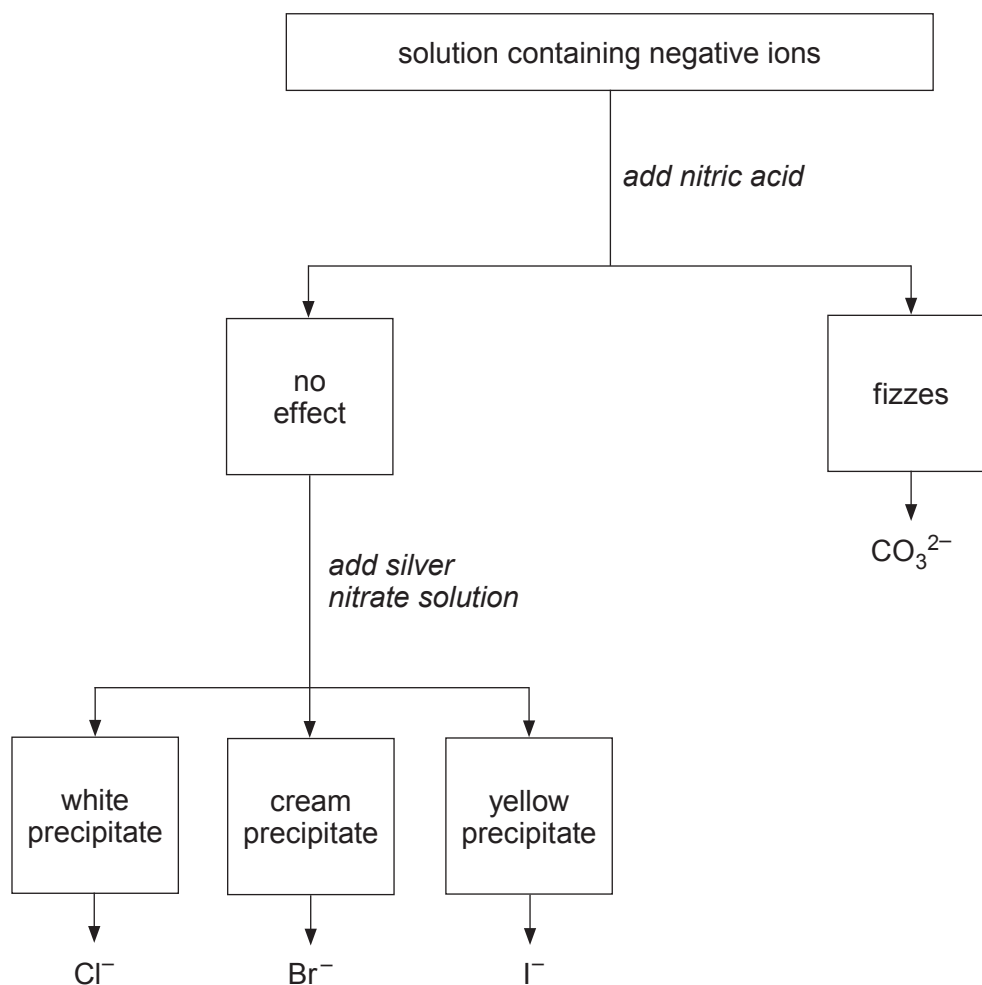

- (a) Give the meaning of the term *precipitate*.

[1]

.....

- (b) Name the gas given off when identifying  $\text{CO}_3^{2-}$  ions.

[1]

.....

(c) Substance **X** was known to be sodium iodide, potassium iodide or potassium bromide.

- (i) State how a flame test could be used to decide whether substance **X** is a sodium or a potassium compound. [2]

.....  
 .....

- (ii) Describe how you would carry out a test to show whether **X** is potassium iodide or potassium bromide. Include the expected observations. [2]

.....  
 .....  
 .....  
 .....

- (iii) Give the **word** equation for the reaction between silver nitrate and potassium bromide. [1]

..... + ..... → ..... + .....

6. A small piece of limestone, which contains calcium carbonate, was heated strongly for about 10 minutes using a Bunsen burner flame as shown in the diagram.

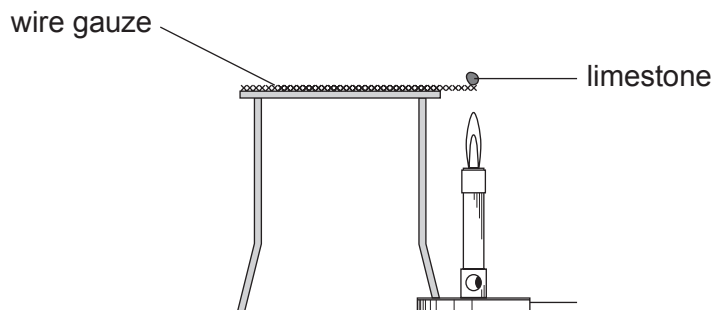

- (a) During the reaction calcium oxide was formed.

Give the common name of calcium oxide.

[1]

.....

- (b) The calcium oxide was allowed to cool and cold water was added dropwise as shown.

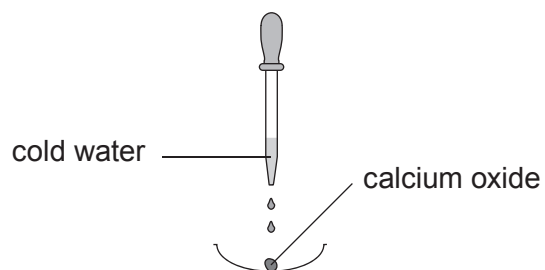

- (i) Describe what was observed.

[2]

.....  
 .....  
 .....

- (ii) Give the balanced **symbol** equation for the reaction.

[2]





**BLANK PAGE**

7. In the Haber process, nitrogen reacts with hydrogen to give ammonia.

The following graphs show the effect of changing pressure on the yield of ammonia at 300 °C and 500 °C.

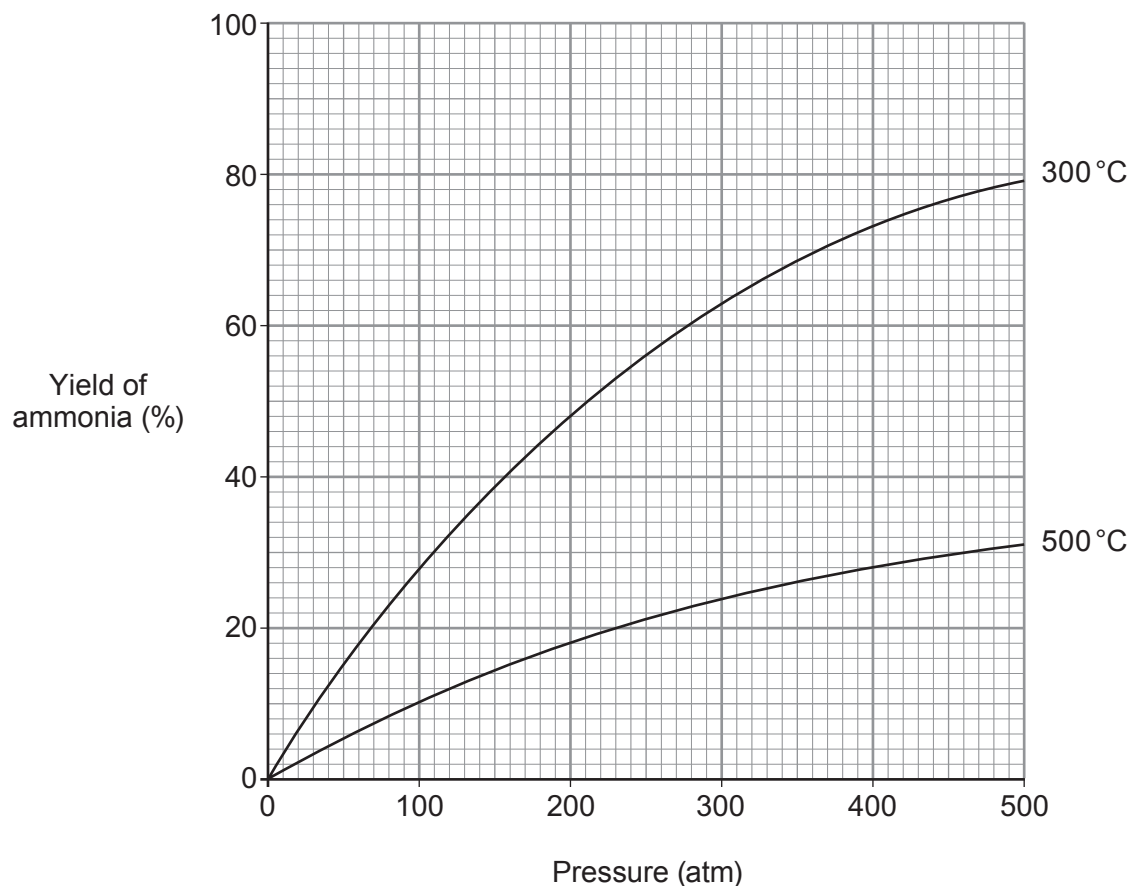

The table shows the percentage yield of ammonia at various pressures at 400 °C.

Pressure (atm)	0	100	200	300	400	500
Yield of ammonia (%)	0	22	37	44	49	51

- (a) Plot the points on the grid above and draw a suitable line. [2]
- (b) Using the graphs, state the temperature and pressure which produce the highest yield of ammonia. [1]

..... °C and ..... atm

(c) State what conclusions can be drawn from the graphs.

[2]

Examiner  
only

.....

.....

.....

(d) (i) Complete and balance the following equation for the production of ammonia.

[2]

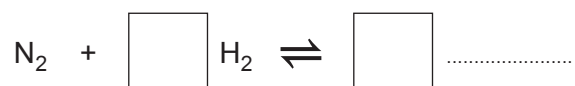

(ii) State the meaning of  $\rightleftharpoons$  in the equation in part (i).

[1]

.....

8

8. The diagram shows the apparatus that was used to find the volume of hydrochloric acid needed to neutralise  $25.0\text{ cm}^3$  of sodium hydroxide solution.

The balanced equation for the reaction between sodium hydroxide and hydrochloric acid is as follows.

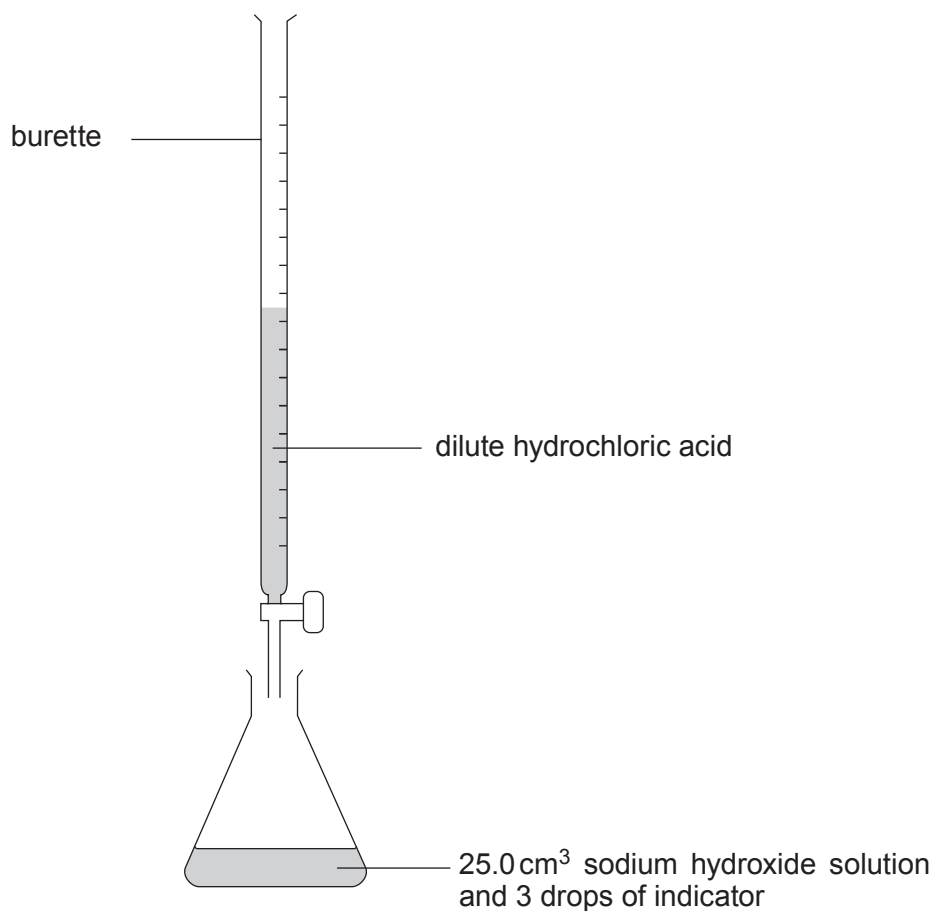

The acid was added slowly from the burette. The volume of acid needed to change the indicator colour was recorded.

The titration was carried out four times and the volume of acid added each time was recorded in the table below.

Run	1	2	3	4
Volume of hydrochloric acid (cm <sup>3</sup> )	33.5	29.5	29.6	29.4

(a) State why an indicator was used in this experiment.

[1]

Examiner  
only

(b) State whether the acid or the alkali is the more concentrated. Give a reason for your answer.

[1]

(c) (i) Calculate the mean volume of hydrochloric acid needed to neutralise  $25.0 \text{ cm}^3$  of the sodium hydroxide solution.

[1]

Mean = .....  $\text{cm}^3$ 

(ii) Using all the information provided and your mean volume, describe how a pure sample of sodium chloride crystals could be made.

[4]

7

Examiner only

9. (a) You have been given three gases, **A**, **B** and **C**. The gases are carbon dioxide, hydrogen and oxygen, but not necessarily in that order.

Describe the tests for carbon dioxide, hydrogen and oxygen and plan a method to identify gases **A**, **B** and **C** **without** using all three tests. [6 QWC]

.....

.....

.....

.....

.....

.....

.....

.....

.....

.....

.....

.....

.....

.....

.....

.....

.....

.....

.....

.....

.....

.....

.....

(b) When a mixture of sodium hydroxide solution and ammonium chloride is heated a gas is given off.

(i) Name the gas. .... [1]

(ii) Describe a test you could carry out to identify the gas. [2]

.....

.....

9

END OF PAPER

## FORMULAE FOR SOME COMMON IONS

POSITIVE IONS		NEGATIVE IONS	
Name	Formula	Name	Formula
Aluminium	$\text{Al}^{3+}$	Bromide	$\text{Br}^-$
Ammonium	$\text{NH}_4^+$	Carbonate	$\text{CO}_3^{2-}$
Barium	$\text{Ba}^{2+}$	Chloride	$\text{Cl}^-$
Calcium	$\text{Ca}^{2+}$	Fluoride	$\text{F}^-$
Copper(II)	$\text{Cu}^{2+}$	Hydroxide	$\text{OH}^-$
Hydrogen	$\text{H}^+$	Iodide	$\text{I}^-$
Iron(II)	$\text{Fe}^{2+}$	Nitrate	$\text{NO}_3^-$
Iron(III)	$\text{Fe}^{3+}$	Oxide	$\text{O}^{2-}$
Lithium	$\text{Li}^+$	Sulfate	$\text{SO}_4^{2-}$
Magnesium	$\text{Mg}^{2+}$		
Nickel	$\text{Ni}^{2+}$		
Potassium	$\text{K}^+$		
Silver	$\text{Ag}^+$		
Sodium	$\text{Na}^+$		
Zinc	$\text{Zn}^{2+}$		

# PERIODIC TABLE OF ELEMENTS

1    2    3    4    5    6    7    0

Group

${}^1_1\text{H}$ Hydrogen								${}^4_2\text{He}$ Helium
${}^7_3\text{Li}$ Lithium	${}^9_4\text{Be}$ Beryllium						${}^{19}_9\text{F}$ Fluorine	${}^{20}_{10}\text{Ne}$ Neon
${}^{23}_{11}\text{Na}$ Sodium	${}^{24}_{12}\text{Mg}$ Magnesium						${}^{32}_{16}\text{S}$ Sulfur	${}^{40}_{18}\text{Ar}$ Argon
${}^{39}_{19}\text{K}$ Potassium	${}^{40}_{20}\text{Ca}$ Calcium	${}^{56}_{26}\text{Fe}$ Iron	${}^{59}_{27}\text{Co}$ Cobalt	${}^{59}_{28}\text{Ni}$ Nickel	${}^{64}_{29}\text{Cu}$ Copper	${}^{65}_{30}\text{Zn}$ Zinc	${}^{79}_{34}\text{Se}$ Selenium	${}^{84}_{36}\text{Kr}$ Krypton
${}^{86}_{37}\text{Rb}$ Rubidium	${}^{88}_{38}\text{Sr}$ Strontium	${}^{101}_{44}\text{Ru}$ Ruthenium	${}^{103}_{45}\text{Rh}$ Rhodium	${}^{106}_{46}\text{Pd}$ Palladium	${}^{108}_{47}\text{Ag}$ Silver	${}^{112}_{48}\text{Cd}$ Cadmium	${}^{128}_{52}\text{Te}$ Tellurium	${}^{131}_{54}\text{Xe}$ Xenon
${}^{133}_{55}\text{Cs}$ Caesium	${}^{137}_{56}\text{Ba}$ Barium	${}^{186}_{76}\text{Os}$ Osmium	${}^{192}_{77}\text{Ir}$ Iridium	${}^{195}_{78}\text{Pt}$ Platinum	${}^{197}_{79}\text{Au}$ Gold	${}^{201}_{80}\text{Hg}$ Mercury	${}^{210}_{84}\text{Po}$ Polonium	${}^{222}_{86}\text{Rn}$ Radon
${}^{223}_{87}\text{Fr}$ Francium	${}^{226}_{88}\text{Ra}$ Radium	${}^{186}_{75}\text{Re}$ Rhenium	${}^{188}_{75}\text{Os}$ Osmium	${}^{195}_{78}\text{Pt}$ Platinum	${}^{197}_{79}\text{Au}$ Gold	${}^{201}_{80}\text{Hg}$ Mercury	${}^{210}_{84}\text{Po}$ Polonium	${}^{222}_{86}\text{Rn}$ Radon
		${}^{184}_{74}\text{W}$ Tungsten	${}^{186}_{75}\text{Re}$ Rhenium	${}^{192}_{77}\text{Ir}$ Iridium	${}^{197}_{79}\text{Au}$ Gold	${}^{201}_{80}\text{Hg}$ Mercury	${}^{210}_{84}\text{Po}$ Polonium	${}^{222}_{86}\text{Rn}$ Radon
		${}^{181}_{73}\text{Ta}$ Tantalum	${}^{186}_{75}\text{Re}$ Rhenium	${}^{192}_{77}\text{Ir}$ Iridium	${}^{197}_{79}\text{Au}$ Gold	${}^{201}_{80}\text{Hg}$ Mercury	${}^{210}_{84}\text{Po}$ Polonium	${}^{222}_{86}\text{Rn}$ Radon
		${}^{179}_{72}\text{Hf}$ Hafnium	${}^{186}_{75}\text{Re}$ Rhenium	${}^{192}_{77}\text{Ir}$ Iridium	${}^{197}_{79}\text{Au}$ Gold	${}^{201}_{80}\text{Hg}$ Mercury	${}^{210}_{84}\text{Po}$ Polonium	${}^{222}_{86}\text{Rn}$ Radon
		${}^{45}_{21}\text{Sc}$ Scandium	${}^{186}_{75}\text{Re}$ Rhenium	${}^{192}_{77}\text{Ir}$ Iridium	${}^{197}_{79}\text{Au}$ Gold	${}^{201}_{80}\text{Hg}$ Mercury	${}^{210}_{84}\text{Po}$ Polonium	${}^{222}_{86}\text{Rn}$ Radon
		${}^{89}_{39}\text{Y}$ Yttrium	${}^{186}_{75}\text{Re}$ Rhenium	${}^{192}_{77}\text{Ir}$ Iridium	${}^{197}_{79}\text{Au}$ Gold	${}^{201}_{80}\text{Hg}$ Mercury	${}^{210}_{84}\text{Po}$ Polonium	${}^{222}_{86}\text{Rn}$ Radon
		${}^{139}_{57}\text{La}$ Lanthanum	${}^{186}_{75}\text{Re}$ Rhenium	${}^{192}_{77}\text{Ir}$ Iridium	${}^{197}_{79}\text{Au}$ Gold	${}^{201}_{80}\text{Hg}$ Mercury	${}^{210}_{84}\text{Po}$ Polonium	${}^{222}_{86}\text{Rn}$ Radon
		${}^{227}_{89}\text{Ac}$ Actinium	${}^{186}_{75}\text{Re}$ Rhenium	${}^{192}_{77}\text{Ir}$ Iridium	${}^{197}_{79}\text{Au}$ Gold	${}^{201}_{80}\text{Hg}$ Mercury	${}^{210}_{84}\text{Po}$ Polonium	${}^{222}_{86}\text{Rn}$ Radon

Key:

