



Cambridge IGCSE™

CANDIDATE
NAME

CENTRE
NUMBER

--	--	--	--	--

CANDIDATE
NUMBER

--	--	--	--



PHYSICS

0625/33

Paper 3 Theory (Core)

October/November 2021

1 hour 15 minutes

You must answer on the question paper.

No additional materials are needed.

INSTRUCTIONS

- Answer **all** questions.
- Use a black or dark blue pen. You may use an HB pencil for any diagrams or graphs.
- Write your name, centre number and candidate number in the boxes at the top of the page.
- Write your answer to each question in the space provided.
- Do **not** use an erasable pen or correction fluid.
- Do **not** write on any bar codes.
- You may use a calculator.
- You should show all your working and use appropriate units.
- Take the weight of 1.0 kg to be 10 N (acceleration of free fall = 10 m/s^2).

INFORMATION

- The total mark for this paper is 80.
- The number of marks for each question or part question is shown in brackets [].

This document has **20** pages. Any blank pages are indicated.

BLANK PAGE

- 1 Fig. 1.1 shows a plant pot falling from an upstairs balcony. The plant pot has a constant acceleration as it falls.

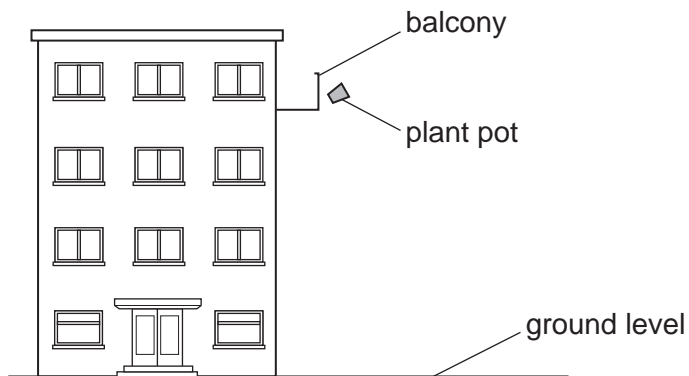

Fig. 1.1

- (a) State the cause of the acceleration.

..... [1]

- (b) Fig. 1.2 shows the speed–time graph for the falling plant pot. The plant pot hits the ground at time = 1.8 s.

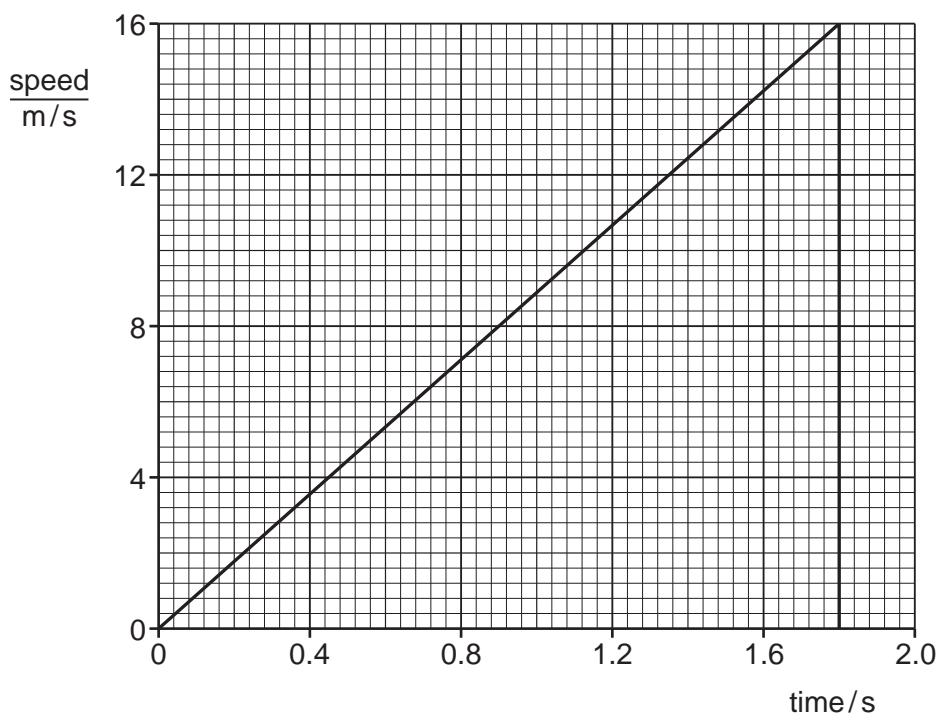

Fig. 1.2

Determine the height of the balcony above the ground using the information shown in Fig. 1.2.

height = m [3]

[Total: 4]

2 Fig. 2.1 shows a pea plant. One of the pods is open, showing the peas inside.



Fig. 2.1

(a) A food scientist needs to find the average diameter of a pea. She places 14 peas against a ruler, as shown in Fig. 2.2.

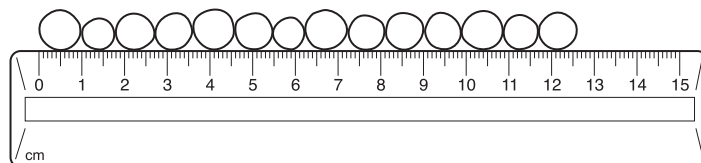

Fig. 2.2

Use information from Fig. 2.2 to determine the average diameter of **one** pea.

average diameter of one pea = cm [3]

5

- (b) The food scientist needs to find the average density of some peas.

She uses the following values:

mass of peas = 183 g

volume of peas = 250 cm³.

Calculate the average density of these peas.

average density =g/cm³ [3]

- (c) A different variety of pea has a density of 0.89 g/cm³. One pea of this variety is placed in salt water. The density of the salt water is 1.02 g/cm³.

State whether this pea floats or sinks in the salt water. Give a reason for your answer.

answer

reason

[1]

[Total: 7]

3 Fig. 3.1 shows the horizontal forces acting on a skateboarder.

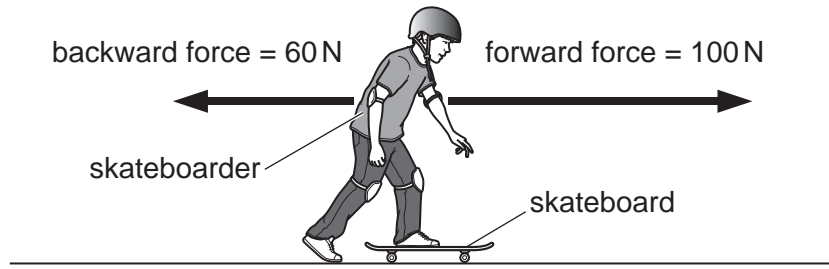

Fig. 3.1

(a) Calculate the resultant force acting on the skateboarder.

resultant force = N

direction = [2]

(b) Describe the effect of the resultant force in (a) on the motion of the skateboarder.

..... [1]

(c) The skateboarder is moving along a horizontal path.

The backward force is 100 N. The forward force is 100 N.

Describe the motion of the skateboarder.

..... [1]

[Total: 4]

4 (a) (i) State the principle of conservation of energy.

.....
 [1]

(ii) Fig. 4.1 shows a type of light bulb. Energy changes occur when electrical energy is supplied to the light bulb, as shown in Fig. 4.1.

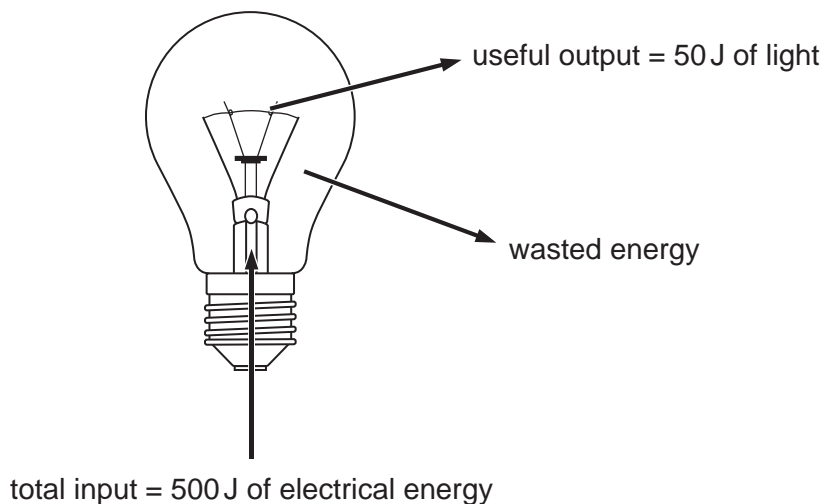

Fig. 4.1

Calculate the wasted energy when the total input energy is 500 J.
 Use information from Fig. 4.1.

wasted energy = J [2]

(iii) Describe the effect of the wasted energy on the air surrounding the light bulb.

..... [1]

(b) Table 4.1 lists situations in which energy is stored.

Complete Table 4.1 by naming the form of energy stored in each situation.

Table 4.1

situation	form of energy stored
battery in a mobile phone	
coal in the ground	
a rotating turbine	
water stored behind a hydroelectric dam	

[4]

[Total: 8]

- 5 Fig. 5.1 shows two metal blocks, A and B, which are the same size and made of the same material. Block A has a dull black surface and block B has a shiny white surface.

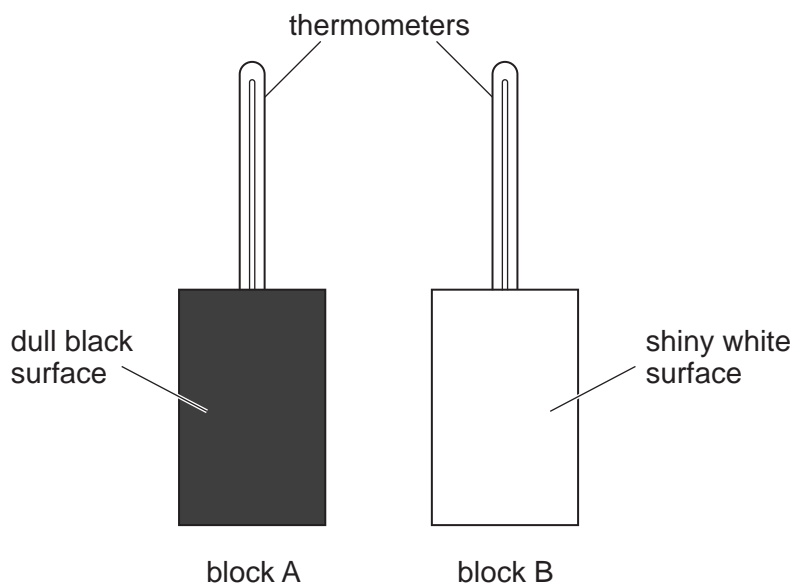

Fig. 5.1

The starting temperature of both blocks is 80°C .

Fig. 5.2 shows the cooling curve for block A.

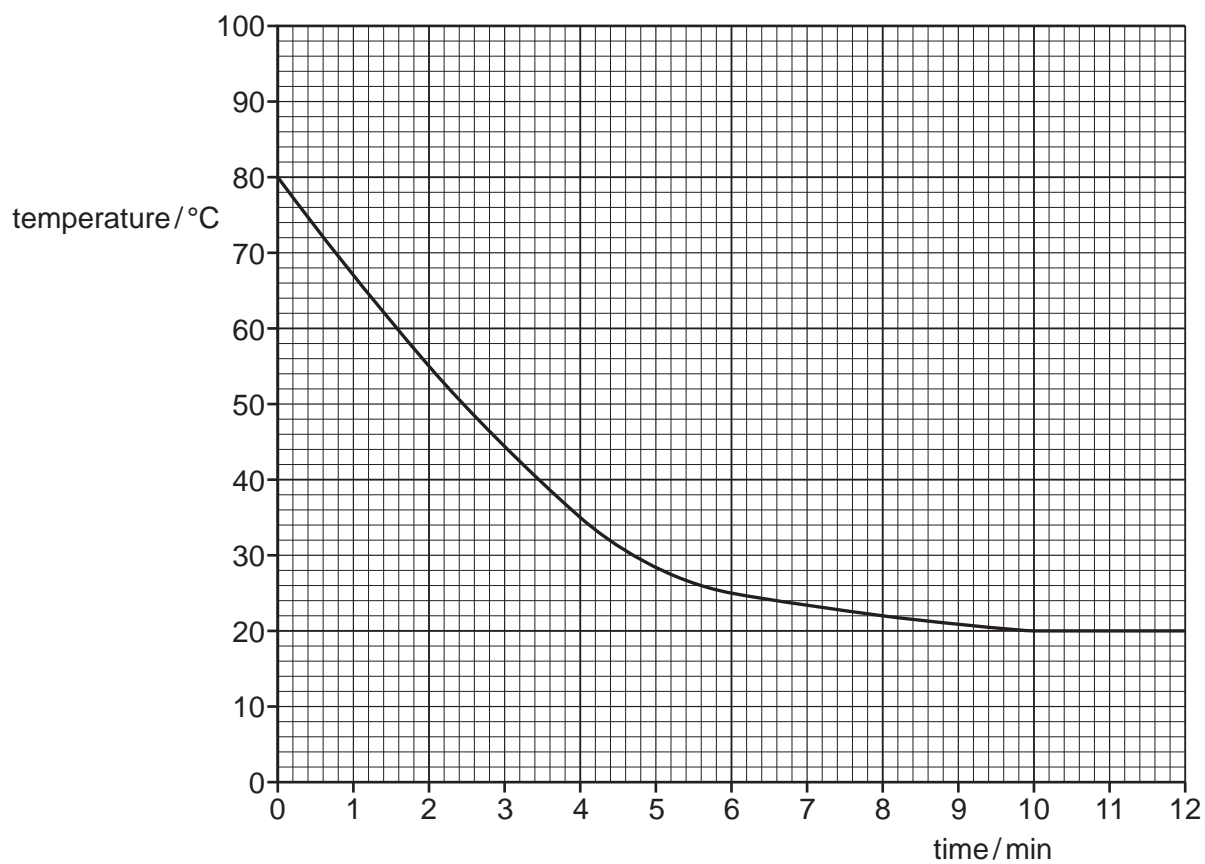

Fig. 5.2

- (a) (i) Using Fig. 5.2, determine the change in temperature for block A from 0 to 2 min.

..... [1]

- (ii) Determine the final temperature of block A.

final temperature = °C [1]

- (iii) Explain why block A has a steady final temperature.

.....
..... [1]

- (b) The results for block B are slightly different from the results for block A.

- (i) Predict the cooling curve for block B by drawing a line on the graph in Fig. 5.2. [3]

- (ii) Explain why the results for block B are slightly different from the results for block A.

.....
..... [1]

[Total: 7]

- 6 (a) In Fig. 6.1, the circles represent molecules. The diagram shows the arrangement of the molecules in a liquid.

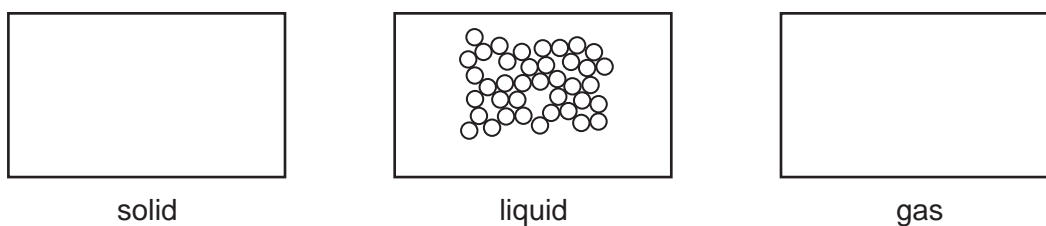

Fig. 6.1

- (i) Show the arrangement of the molecules in a solid.

Draw a diagram in the box above the word 'solid' in Fig. 6.1. Draw at least **10** molecules. [2]

- (ii) Show the arrangement of the molecules in a gas.

Draw a diagram in the box above the word 'gas' in Fig. 6.1. Draw at least **10** molecules. [2]

- (iii) State the name of the process by which a solid changes into a liquid.

..... [1]

- (iv) State the name of the process by which a gas changes into a liquid.

..... [1]

- (b) Fig. 6.2 shows a microscope used for viewing smoke particles in a small glass box. A bright light shines into the box.

The box contains smoke particles and air molecules.

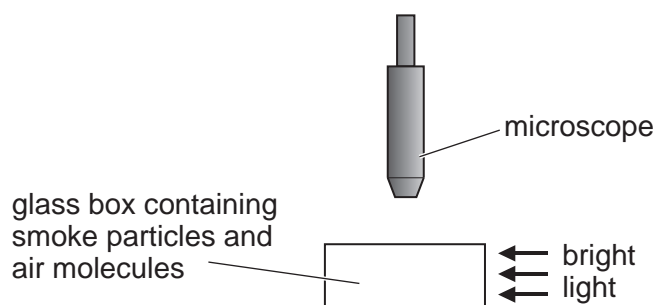

Fig. 6.2

A student views the smoke particles through the microscope.

The smoke particles are moving.

- (i) State the name given to the movement of the smoke particles.

..... [1]

- (ii) Fig. 6.3 shows a smoke particle as seen with the microscope.

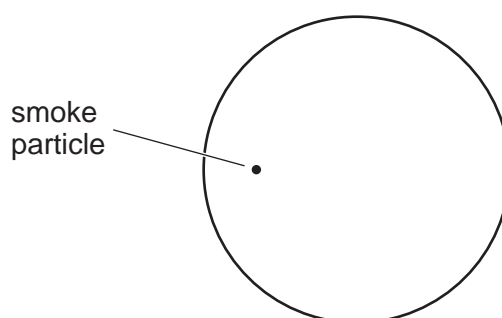

Fig. 6.3

Show how the smoke particle moves by drawing a series of lines on Fig. 6.3. [2]

- (iii) The temperature in the glass box decreases.

Describe any changes in the movement of the smoke particles.

..... [1]

[Total: 10]

7 A group of students are taking measurements so they can calculate the speed of sound.

The students and their teacher are outside.

The teacher holds two blocks of wood and the students have stop-watches.

The teacher stands a long distance from the students, as shown in Fig. 7.1.

All the students can see the teacher clearly.



Fig. 7.1 (not to scale)

The teacher claps the two blocks of wood together to produce a loud sound. The students measure the time interval between seeing the teacher clap and hearing the sound.

(a) Fig. 7.2 shows three of the stop-watches. The stop-watches show three of the values recorded for the time interval.



Fig. 7.2

Calculate the average value for the time intervals shown on the stop-watches in Fig. 7.2.

average time interval = s [3]

13

- (b) (i) State the name of the instrument needed to measure the distance between the teacher and the students.

..... [1]

- (ii) The distance between the teacher and the students is 415 m.

The average time for the sound to travel between the teacher and the students is 1.29 s.

Calculate the speed of sound.

speed of sound = m/s [3]

[Total: 7]

- 8 (a) The diagram in Fig. 8.1 shows a ray of light travelling from a glass block into air.

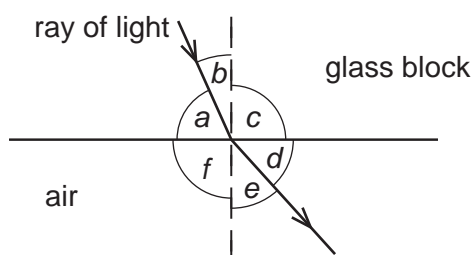

Fig. 8.1

- (i) State the name for the dashed line shown in Fig. 8.1.

..... [1]

- (ii) State the letter, *a*, *b*, *c*, *d*, *e* or *f*, which indicates the angle of incidence of the ray in Fig. 8.1.

..... [1]

- (iii) State the letter, *a*, *b*, *c*, *d*, *e* or *f*, which indicates the angle of refraction of the ray in Fig. 8.1.

..... [1]

(b) The diagram in Fig. 8.2 shows an object and a thin converging lens.

Two rays are drawn from the object to the lens. The points marked F are the principal foci of the lens.

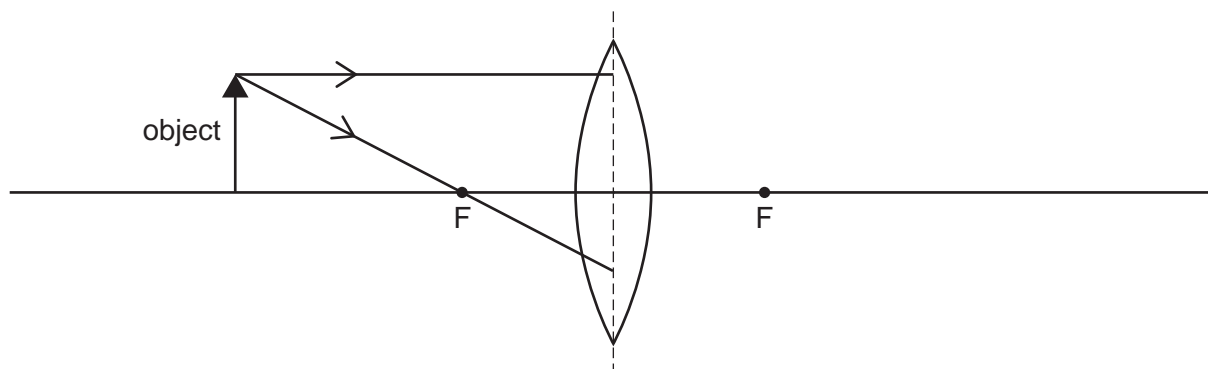

Fig. 8.2

- (i) Continue the paths of the **two** rays in Fig. 8.2 to show how the lens forms an image of the object. [2]
- (ii) On Fig. 8.2, draw an arrow to represent the image. [1]
- (iii) Tick (✓) **two** rows to indicate the nature of the image formed by the lens in Fig. 8.2.

nature of image	tick
enlarged	
the same size	
diminished	
upright	
inverted	

[2]

[Total: 8]

- 9 (a) The circuit diagrams in Fig. 9.1 and Fig. 9.2 each show two resistors connected to a battery.
- Fig. 9.1 shows two resistors connected in series.
- Fig. 9.2 shows two resistors connected in parallel.
- All the resistors have the same resistance. Ignore the resistance of the ammeters.

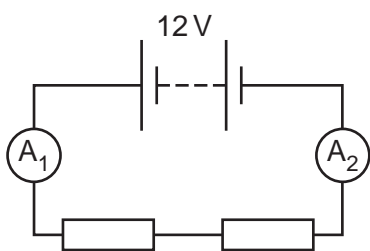

Fig. 9.1

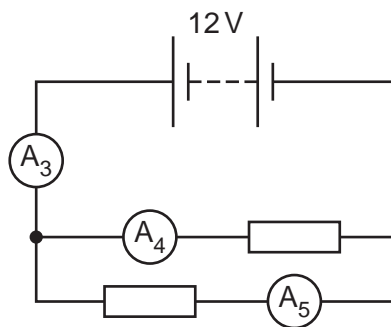

Fig. 9.2

Compare the currents in the ammeters by completing the sentences.

- (i) The current in A_1 is the current in A_2 . [1]
- (ii) The current in A_3 is the current in A_4 . [1]
- (iii) The current in A_4 is the current in A_5 . [1]
- (iv) The current in A_1 is the current in A_3 . [1]

- (b) The lights in a room are connected in parallel with a power supply.

State **one** advantage of connecting the lights in parallel.

..... [1]

(c) The circuit diagram in Fig. 9.3 shows a resistor Q connected to a battery.

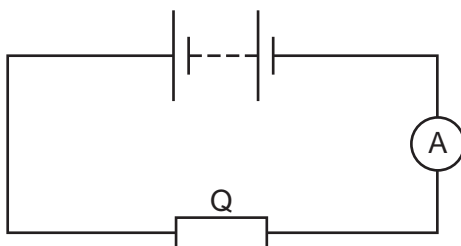

Fig. 9.3

The current in resistor Q is 0.048A. The potential difference (p.d.) across resistor Q is 12V.

Calculate the resistance of resistor Q. Include the unit in your answer.

resistance = unit [4]

[Total: 9]

- 10 (a) Fig. 10.1 shows the arrangement for transferring electrical energy from a power station to homes and factories.

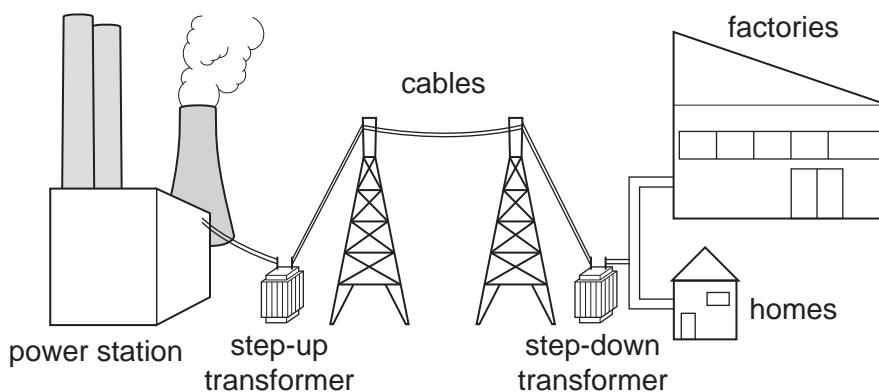

Fig. 10.1

Explain why the arrangement includes a step-up transformer and a step-down transformer.

.....

.....

.....

.....

..... [4]

- (b) A transformer has 2000 turns on the primary coil and 500 turns on the secondary coil. The potential difference (p.d.) across the primary coil is 240 V a.c.

Calculate the p.d. across the secondary coil.

p.d. across the secondary coil =V [3]

[Total: 7]

- 11 (a) Table 11.1 gives information about the nature and charge of three types of radioactive emission. The table is incomplete.

Table 11.1

type of radioactive emission	nature	charge
α (alpha)	helium nucleus	
β (beta)		negative
γ (gamma)		

Complete Table 11.1. [4]

- (b) (i) State which radioactive emission is the most ionising.

..... [1]

- (ii) State which radioactive emission is the most penetrating.

..... [1]

- (c) Californium-241 is a radioactive isotope. A scientist measures the count rate from a sample of californium-241 as it decays. Table 11.2 shows the results.

Table 11.2

time/min	$\frac{\text{count rate}}{\text{counts/s}}$
0	800
2	560
4	400
6	280
8	200
10	140
12	100
14	

- (i) Determine the half-life of californium-241.

half-life of californium-241 = min [2]

- (ii) Predict the count rate of this sample of californium-241 at time = 14 min.

count rate =counts/s [1]

[Total: 9]

Permission to reproduce items where third-party owned material protected by copyright is included has been sought and cleared where possible. Every reasonable effort has been made by the publisher (UCLES) to trace copyright holders, but if any items requiring clearance have unwittingly been included, the publisher will be pleased to make amends at the earliest possible opportunity.

To avoid the issue of disclosure of answer-related information to candidates, all copyright acknowledgements are reproduced online in the Cambridge Assessment International Education Copyright Acknowledgements Booklet. This is produced for each series of examinations and is freely available to download at www.cambridgeinternational.org after the live examination series.

Cambridge Assessment International Education is part of the Cambridge Assessment Group. Cambridge Assessment is the brand name of the University of Cambridge Local Examinations Syndicate (UCLES), which itself is a department of the University of Cambridge.