



Cambridge IGCSE™

PHYSICS

0625/23

Paper 2 Multiple Choice (Extended)

May/June 2022

45 minutes

You must answer on the multiple choice answer sheet.

You will need: Multiple choice answer sheet
Soft clean eraser
Soft pencil (type B or HB is recommended)

INSTRUCTIONS

- There are **forty** questions on this paper. Answer **all** questions.
- For each question there are four possible answers **A**, **B**, **C** and **D**. Choose the **one** you consider correct and record your choice in soft pencil on the multiple choice answer sheet.
- Follow the instructions on the multiple choice answer sheet.
- Write in soft pencil.
- Write your name, centre number and candidate number on the multiple choice answer sheet in the spaces provided unless this has been done for you.
- Do **not** use correction fluid.
- Do **not** write on any bar codes.
- You may use a calculator.
- Take the weight of 1.0 kg to be 10 N (acceleration of free fall = 10 m/s^2).

INFORMATION

- The total mark for this paper is 40.
- Each correct answer will score one mark.
- Any rough working should be done on this question paper.

This document has **20** pages. Any blank pages are indicated.



2

1 What is a micrometer screw gauge used to measure?

- A very small currents
- B very small distances
- C very small forces
- D very small pressures

2 A man stands next to a railway track.

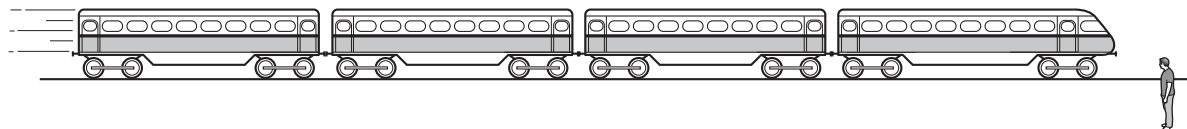

A train travelling at 40 m/s takes 2.0 s to pass the man.

What is the length of the train?

- A 20 m B 38 m C 40 m D 80 m

3 A skydiver jumps from an aeroplane and falls towards the Earth.

Which statement is correct when the skydiver has reached terminal velocity?

- A The skydiver's speed is decreasing.
- B The skydiver's speed is increasing.
- C The skydiver is moving with constant speed.
- D The skydiver's speed is zero.

4 On the Moon, all objects fall with the same acceleration.

Which statement explains this?

- A On the Moon, all objects have the same weight.
- B The Moon has a smaller gravitational field strength than the Earth.
- C The weight of an object is directly proportional to its mass.
- D The weight of an object is inversely proportional to its mass.

3

- 5 A measuring cylinder contains 30 cm^3 of a liquid.

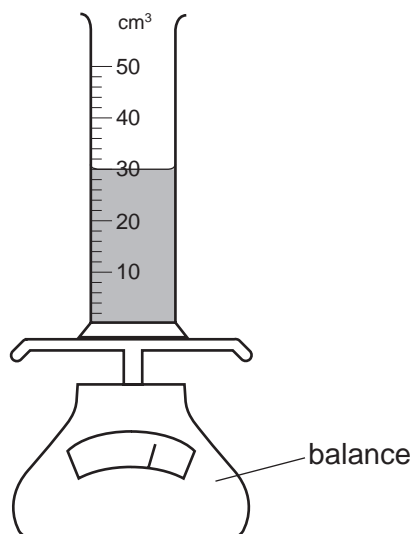

Some more of the liquid is added until the liquid level reaches the 50 cm^3 mark.

The reading on the balance increases by 30 g.

What is the density of the liquid?

- A** 0.60 g/cm^3 **B** 0.67 g/cm^3 **C** 1.5 g/cm^3 **D** 1.7 g/cm^3
- 6 A box of mass 4.0 kg is pulled along a horizontal floor in a straight line by a constant force F .
- The constant frictional force acting on the box is 2.0 N .
- The speed of the box increases from 0.50 m/s to 2.5 m/s in 2.0 s .
- What is the value of F ?

- A** 2.0 N **B** 4.0 N **C** 6.0 N **D** 7.0 N

4

- 7 A beam is pivoted at one end, as shown.

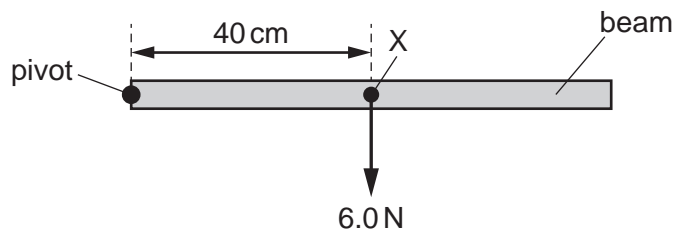

The beam weighs 6.0 N and its weight acts at a point X 40 cm from the pivot.

A force of 4.0 N is applied to the beam causing it to balance horizontally.

In which direction and where is the 4.0 N force applied?

- A vertically downwards at 20 cm to the left of X
 - B vertically downwards at 20 cm to the right of X
 - C vertically upwards at 20 cm to the left of X
 - D vertically upwards at 20 cm to the right of X
- 8 Two vectors, WX and WZ, are as shown.

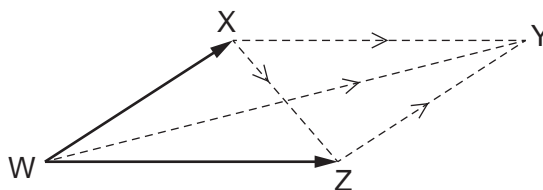

What is the resultant of the vectors?

- A WY
 - B XY
 - C XZ
 - D ZY
- 9 Which equation for impulse is correct?

- A impulse = Ft
- B impulse = $\frac{F}{t}$
- C impulse = $(mv - mu)t$
- D impulse = $\frac{(mv - mu)}{t}$

- 10 A ball of mass 0.16 kg is moving forwards at a speed of 0.50 m/s. A second ball of mass 0.10 kg is stationary. The first ball strikes the second ball. The second ball moves forwards at a speed of 0.50 m/s.

What is the speed of the first ball after the collision?

- A 0.0 m/s B 0.19 m/s C 0.31 m/s D 0.50 m/s
- 11 In which form is energy stored by stretching a spring?
- A chemical energy
B elastic potential energy
C gravitational potential energy
D thermal energy
- 12 A car moves along a horizontal road. Its initial kinetic energy is 280 kJ. A constant resistive force of 200 N acts on the car. No other horizontal forces act on the car.

What is the kinetic energy of the car after it has travelled a distance of 300 m?

- A 60 kJ B 80 kJ C 220 kJ D 340 kJ
- 13 The diagram shows a deep reservoir formed by a dam.

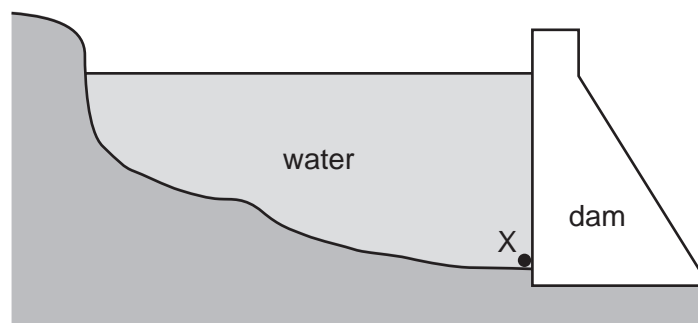

On what does the pressure at X depend?

- A the depth of the water at X
B the length of the reservoir
C the surface area of the water
D the thickness of the dam wall

- 14 The diagram shows gas particles hitting the wall of a container. The system is at room temperature.

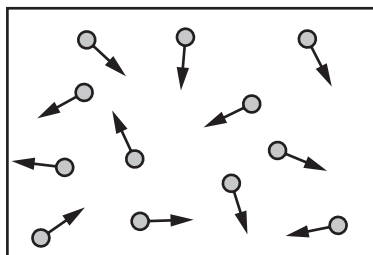

Why do the gas particles exert a pressure on the wall?

- A When the particles hit the wall, their momentum changes, which causes a force.
 - B When the particles hit the wall, their average kinetic energy increases.
 - C The particles expand when they hit the wall.
 - D The particles collide with each other.
- 15 A gas in a container is cooled but the volume of the gas does not change.

Which row describes the changes in the pressure of the gas and the kinetic energy of the gas particles?

	pressure of gas	kinetic energy of gas particles
A	decreases	decreases
B	decreases	increases
C	increases	decreases
D	increases	increases

- 16 The iron cylinder of an engine is to be fitted into a piece of aluminium.

The outside diameter M of the iron cylinder is slightly larger than the diameter N of the hole in the aluminium.

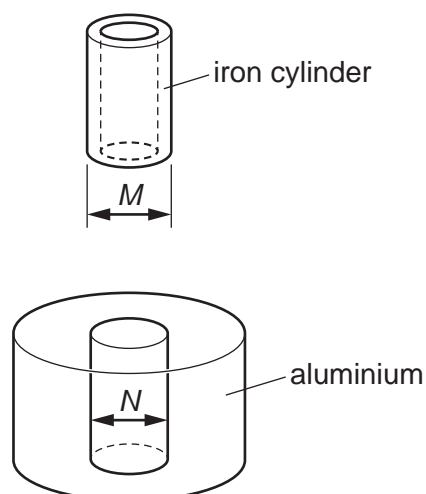

What is the best action to fit the cylinder into the aluminium?

- A Cool the aluminium and cool the iron.
 - B Cool the aluminium and heat the iron.
 - C Heat the aluminium and cool the iron.
 - D Heat the aluminium and heat the iron.
- 17 Four metal blocks at a temperature of $200\text{ }^{\circ}\text{C}$ are left to cool down to the same temperature.

The table gives the mass of each block and the energy it transfers to the surroundings as it cools.

block	mass/g	energy transferred/J
1	100	16 200
2	150	16 200
3	200	32 400
4	200	8 100

Which two blocks are made of the same metal?

- A 1 and 2
- B 1 and 3
- C 1 and 4
- D 3 and 4

- 18 A glass contains an iced drink on a warm and humid day. Water starts to form on the outside of the glass.

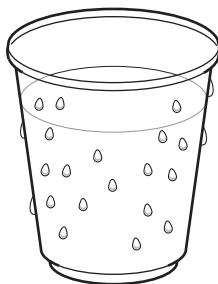

What is the name of the effect by which the water forms?

- A condensation
 - B conduction
 - C convection
 - D evaporation
- 19 One end of a copper bar is heated to a high temperature.
- Which mechanism is responsible for the transfer of thermal energy to the other end of the copper bar?
- A the lattice vibrations of copper ions only
 - B the lattice vibrations of copper ions and the movement of high energy electrons along the bar
 - C the movement of high energy copper ions along the bar
 - D the movement of high energy electrons along the bar only
- 20 An object emits infrared radiation.
- Which two properties of the object determine the rate of radiation of thermal energy from the object?
- A the density and the surface area of the object
 - B the density and the surface temperature of the object
 - C the mass and the surface area of the object
 - D the surface area and the surface temperature of the object

21 The diagram shows a wave.

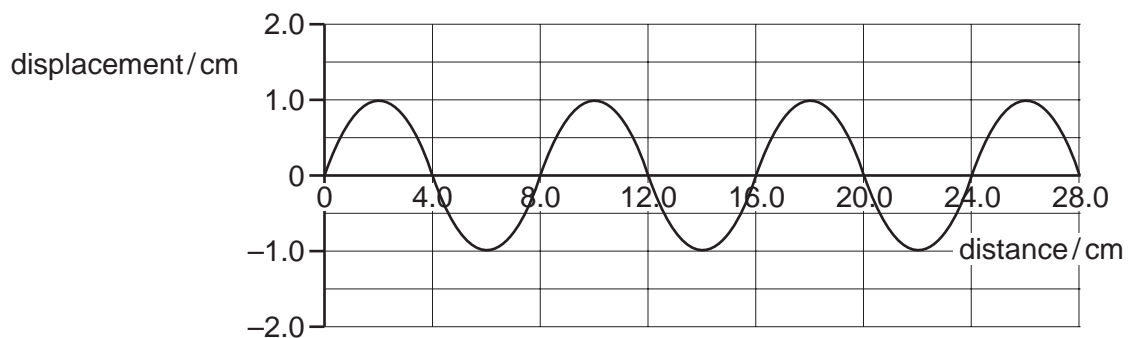

Which row is correct?

	amplitude of the wave / cm	wavelength of the wave / cm
A	1.0	4.0
B	1.0	8.0
C	2.0	4.0
D	2.0	8.0

22 The wavelength of a beam of X-rays, travelling through air, is 5.4×10^{-10} m.

What is its frequency?

- A** 5.6×10^{-17} Hz
- B** 5.6×10^{11} Hz
- C** 5.6×10^{17} Hz
- D** 5.6×10^{18} Hz

- 23 A ray of light passes from air through a sheet of glass and out the other side, as shown.

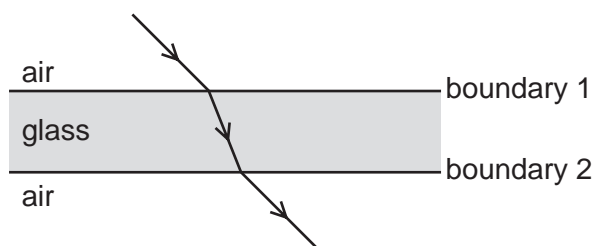

Which two angles are equal to each other?

- A angle of incidence at boundary 1 and angle of incidence at boundary 2
- B angle of incidence at boundary 1 and angle of refraction at boundary 1
- C angle of incidence at boundary 1 and angle of refraction at boundary 2
- D angle of refraction at boundary 1 and angle of refraction at boundary 2

- 24 A plane mirror is fixed to a vertical wall.

A boy looks at the image of himself in the mirror.

Which statement describes the image formed?

- A real and upright
- B real and upside down
- C virtual and upright
- D virtual and upside down

- 25 The speed of light in air is 3.0×10^8 m/s.

The critical angle for light in a transparent plastic material placed in air is 37° .

What is the speed of light in the plastic material?

- A 1.8×10^8 m/s
- B 2.4×10^8 m/s
- C 3.8×10^8 m/s
- D 5.0×10^8 m/s

- 26 A resistor and a battery are connected in series.

The value of the resistor is $20\ \Omega$.

The potential difference (p.d.) of the battery is $4.0\ \text{V}$.

What is the current in the resistor?

- A** $0.20\ \text{A}$ **B** $4.0\ \text{A}$ **C** $5.0\ \text{A}$ **D** $80\ \text{A}$

- 27 Which statement correctly compares radio waves and X-rays?

- A** Radio waves have a longer wavelength and a greater speed in a vacuum.
B Radio waves have a longer wavelength and the same speed in a vacuum.
C Radio waves have a shorter wavelength and a greater speed in a vacuum.
D Radio waves have a shorter wavelength and the same speed in a vacuum.

- 28 A student attempts to make a permanent magnet by hammering metal bars of the same size in the same magnetic field.

In which case is the strongest permanent magnet produced?

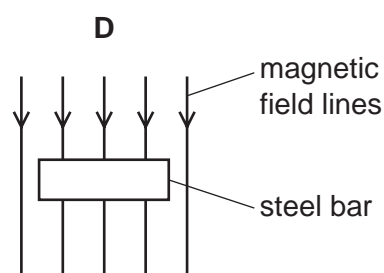
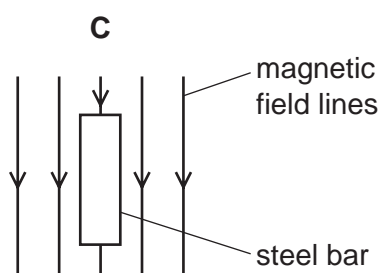
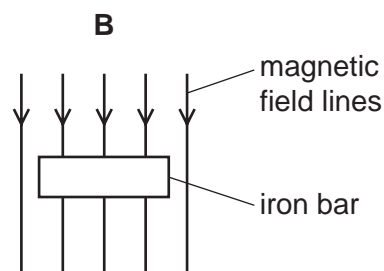
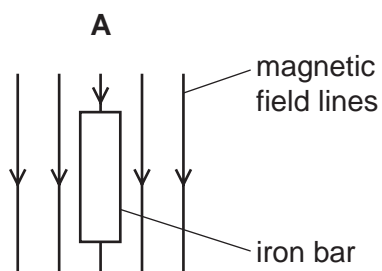

29 A metal sphere R is suspended on an insulating thread.

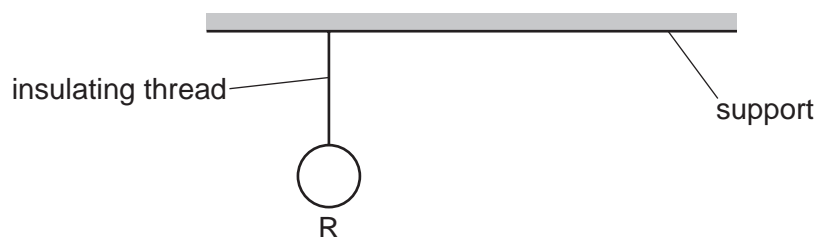

Another sphere S is brought close to sphere R. Sphere S has a negative charge and is attached to a plastic stand. The diagram shows the spheres when they are close to each other.

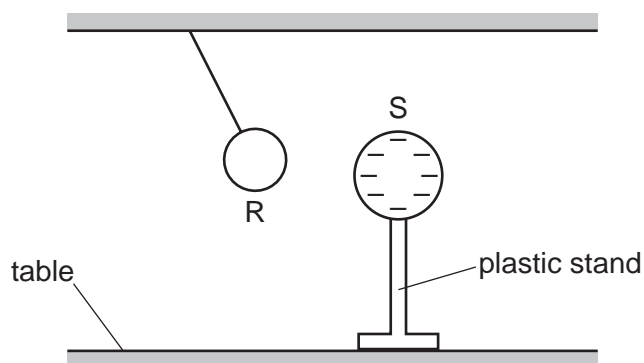

Which charged state of R accounts for the behaviour in the diagram?

- A negative only
- B positive only
- C negative or uncharged
- D positive or uncharged

30 A student compares the wavelength and uses of infrared waves with microwaves.

Which row is correct?

	wavelength of infrared compared to microwaves	use of infrared waves
A	longer	intruder alarms
B	longer	satellite television
C	shorter	intruder alarms
D	shorter	satellite television

31 There is a current I in a resistor for a time t . The potential difference (p.d.) across the resistor is V .

A student calculates the product IVt .

In which unit is the student's answer measured?

- A ampere
- B coulomb
- C joule
- D watt

32 Which statement about identical lamps in a parallel circuit is **not** correct?

- A If one lamp blows, the others remain switched on.
- B The current in each lamp is different.
- C The lamps can be switched on and off separately.
- D The lamps have the same voltage across each of them.

33 The four circuits shown each contain four diodes.

In which circuit is the direction of the current in the resistor always from the red terminal to the black terminal?

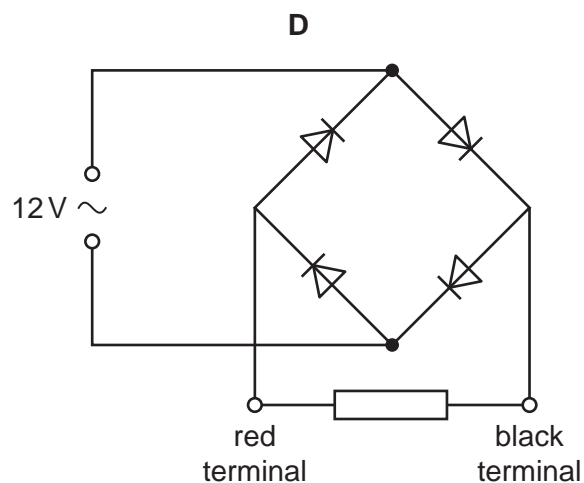
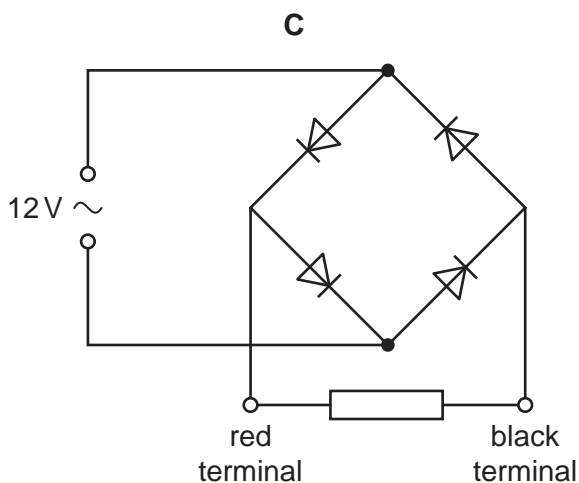
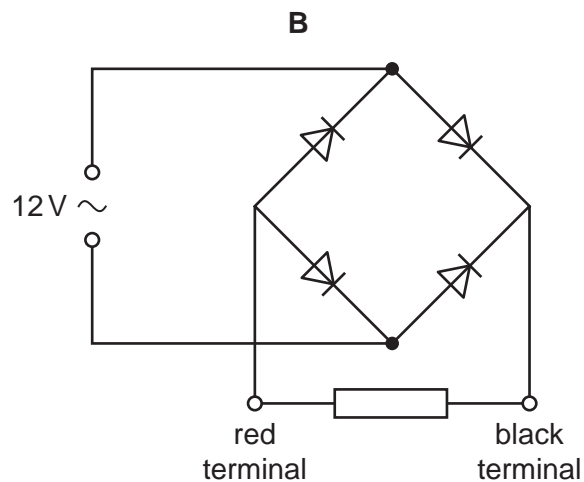
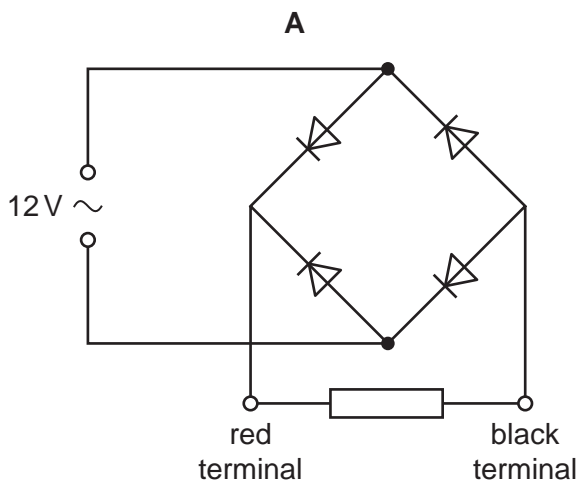

34 The truth table for a logic gate is shown.

inputs		output
0	0	1
0	1	1
1	0	1
1	1	0

Which type of logic gate is it?

A AND

B NAND

C OR

D NOR

35 A wire XY is connected to a resistor R. The wire is moved in the magnetic field between two magnetic poles.

In which direction must the wire be moved so that the induced current is in the direction shown?

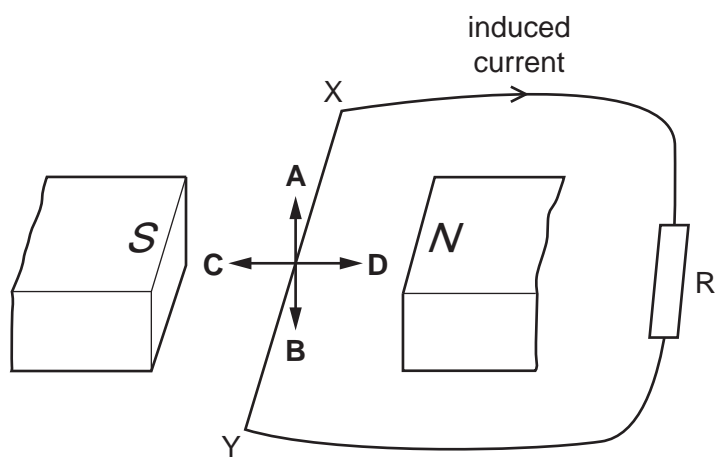

36 Which transformer can change a 240 V a.c. input into a 15 V a.c. output?

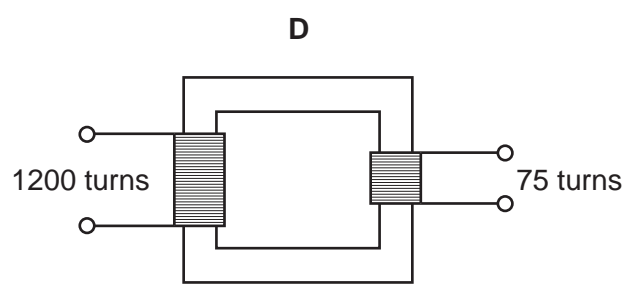
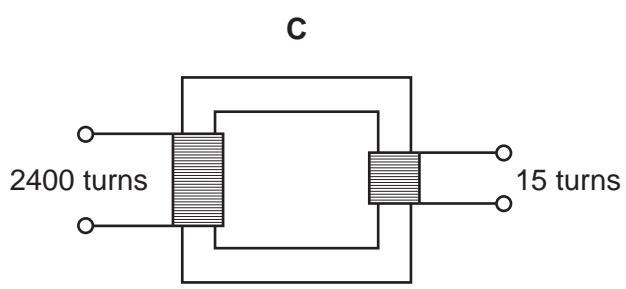
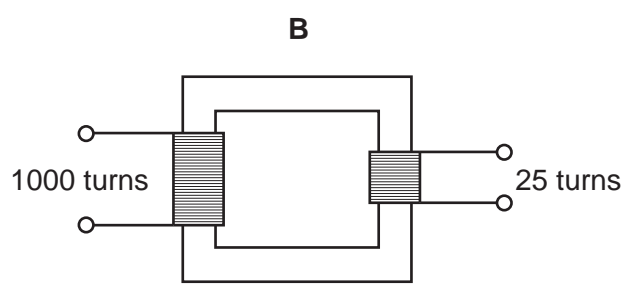
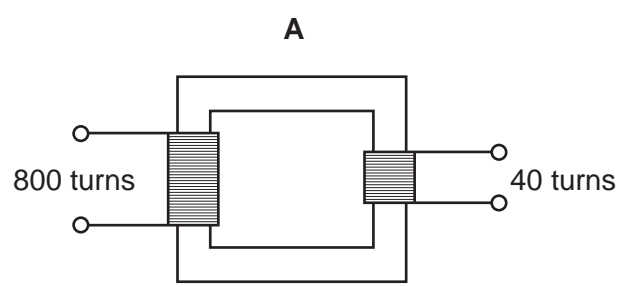

37 The circuit shown consists of a vertical wire, a resistor R and a battery.

The magnetic field near the wire is also shown.

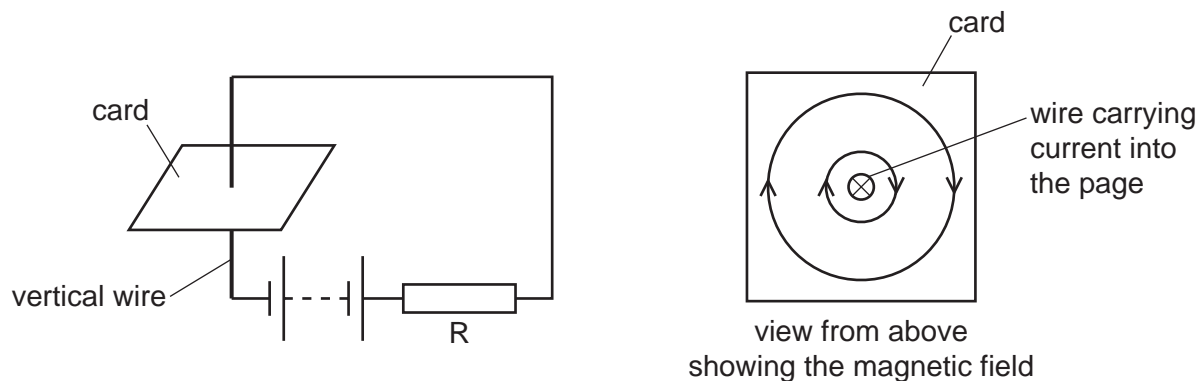

Two changes are made to the circuit:

- The polarity of the battery is reversed.
- The resistor R is replaced with another resistor with a lower resistance than R.

What effect will these changes have on the magnetic field near the wire?

	direction of magnetic field	strength of magnetic field
A	opposite	same
B	same	weaker
C	opposite	stronger
D	same	stronger

38 Carbon-14 has a proton number (Z) of 6 and a nucleon number (A) of 14.

Nitrogen-14 has a proton number of 7 and a nucleon number of 14.

Carbon-14 emits β -particles to form nitrogen-14.

Which nuclide equation describes this process?

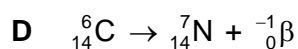
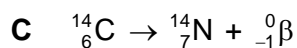
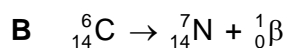
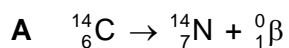

- 39 A beam of radiation, containing α -particles, β -particles and γ -rays, passes between two parallel plates. One plate is positively charged and the other is negatively charged.

Which radioactive emissions will be attracted towards the positively charged plate?

- A α -particles only
 B β -particles only
 C γ -rays only
 D α -particles, β -particles and γ -rays
- 40 A scientist uses a counter to measure the radioactivity of a sample of nitrogen-13.

The counter and sample of nitrogen-13 are on a table in a laboratory.

The reading on the counter is recorded for a period of 80 min and a graph is drawn using the measurements.

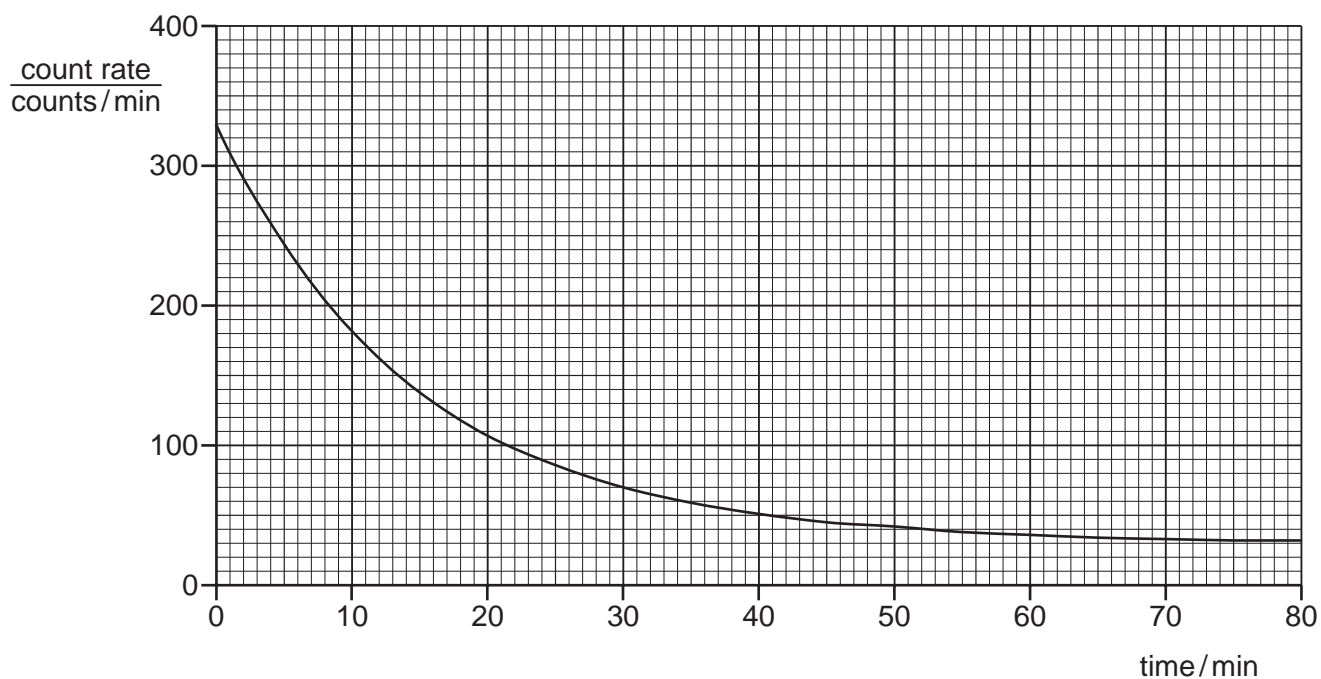

What is the best estimate for the half-life of the sample of nitrogen-13?

- A 10 min B 12 min C 14 min D 40 min

BLANK PAGE

BLANK PAGE

BLANK PAGE

Permission to reproduce items where third-party owned material protected by copyright is included has been sought and cleared where possible. Every reasonable effort has been made by the publisher (UCLES) to trace copyright holders, but if any items requiring clearance have unwittingly been included, the publisher will be pleased to make amends at the earliest possible opportunity.

To avoid the issue of disclosure of answer-related information to candidates, all copyright acknowledgements are reproduced online in the Cambridge Assessment International Education Copyright Acknowledgements Booklet. This is produced for each series of examinations and is freely available to download at www.cambridgeinternational.org after the live examination series.

Cambridge Assessment International Education is part of Cambridge Assessment. Cambridge Assessment is the brand name of the University of Cambridge Local Examinations Syndicate (UCLES), which is a department of the University of Cambridge.