



# Mark Scheme (Results)

## November 2020

Pearson Edexcel GCSE  
In Physics (1PH0) Paper 2H

## **Edexcel and BTEC Qualifications**

Edexcel and BTEC qualifications are awarded by Pearson, the UK's largest awarding body. We provide a wide range of qualifications including academic, vocational, occupational and specific programmes for employers. For further information visit our qualifications websites at [www.edexcel.com](http://www.edexcel.com) or [www.btec.co.uk](http://www.btec.co.uk). Alternatively, you can get in touch with us using the details on our contact us page at [www.edexcel.com/contactus](http://www.edexcel.com/contactus).

### **Pearson: helping people progress, everywhere**

Pearson aspires to be the world's leading learning company. Our aim is to help everyone progress in their lives through education. We believe in every kind of learning, for all kinds of people, wherever they are in the world. We've been involved in education for over 150 years, and by working across 70 countries, in 100 languages, we have built an international reputation for our commitment to high standards and raising achievement through innovation in education. Find out more about how we can help you and your students at: [www.pearson.com/uk](http://www.pearson.com/uk)

November 2020

Publications Code 1PH0\_2H\_2011\_MS

All the material in this publication is copyright

© Pearson Education Ltd 2020

## General Marking Guidance

- All candidates must receive the same treatment. Examiners must mark the first candidate in exactly the same way as they mark the last.
- Mark schemes should be applied positively. Candidates must be rewarded for what they have shown they can do rather than penalised for omissions.
- Examiners should mark according to the mark scheme not according to their perception of where the grade boundaries may lie.
- There is no ceiling on achievement. All marks on the mark scheme should be used appropriately.
- All the marks on the mark scheme are designed to be awarded. Examiners should always award full marks if deserved, i.e. if the answer matches the mark scheme. Examiners should also be prepared to award zero marks if the candidate's response is not worthy of credit according to the mark scheme.
- Where some judgement is required, mark schemes will provide the principles by which marks will be awarded and exemplification may be limited.
- When examiners are in doubt regarding the application of the mark scheme to a candidate's response, the team leader must be consulted.
- Crossed out work should be marked UNLESS the candidate has replaced it with an alternative response.

Mark schemes have been developed so that the rubrics of each mark scheme reflects the characteristics of the skills within the AO being targeted and the requirements of the command word. So for example the command word 'Explain' requires an identification of a point and then reasoning/justification of the point.

Explain questions can be asked across all AOs. The distinction comes whether the identification is via a judgment made to reach a conclusion, or, making a point through application of knowledge to reason/justify the point made through application of understanding. It is the combination and linkage of the marking points that is needed to gain full marks.

When marking questions with a 'describe' or 'explain' command word, the detailed marking guidance below should be consulted to ensure consistency of marking.

Assessment Objective		Command Word	
Strand	Element	Describe	Explain
AO1*		An answer that combines the marking points to provide a logical description	An explanation that links identification of a point with reasoning/justification(s) as required
AO2		An answer that combines the marking points to provide a logical description, showing application of knowledge and understanding	An explanation that links identification of a point (by applying knowledge) with reasoning/justification (application of understanding)
AO3	1a and 1b	An answer that combines points of interpretation/evaluation to provide a logical description	
AO3	2a and 2b		An explanation that combines identification via a judgment to reach a conclusion via justification/reasoning
AO3	3a	An answer that combines the marking points to provide a logical description of the plan/method/experiment	
AO3	3b		An explanation that combines identifying an improvement of the experimental procedure with a linked justification/reasoning

\*there will be situations where an AO1 question will include elements of recall of knowledge directly from the specification (up to a maximum of 15%). These will be identified by an asterisk in the mark scheme.

Question number	Answer	Mark
1(a)	B  A,C and D are incorrect as the forces would cause the seesaw to turn	(1)

Question number	Answer	Additional guidance	Mark
1(b)	an explanation linking distance from hinge/pivot increased (1)  (therefore) smaller force needed (to close door)	P further from hinge than Q  accept the greater distance gives greater moment for 2 marks	(2)

Question number	Answer	Additional guidance	Mark
1(c)	any correct moment (1)  $450 \times 0.50$ or 225 or $0.80 \times F_2$  substitution into prin. of moment equation (1)  $450 \times 0.50 = 0.80 \times F_2$  evaluation (1)  280 (N) (for question at end)	allow $450 \times 0.3$ moment taken about B  allow statement of prin. of moments  accept numbers which round to 280 such as 281.25 award full marks for correct answer without working.	(3)

## Total marks for question 1 =6

Question number	Answer	Additional guidance	Mark
2(a)(i)	<p>an explanation linking any three of the following :</p> <p>use a measuring cylinder/beaker or use a eureka can /displacement can/container with spout (1)</p> <p>(partly)fill measuring cylinder/beaker (with water) note the reading or fill (eureka) can to spout (1)</p> <p>immerse piece of copper (in water) (1)</p> <p>note difference in readings of water level (in measuring cylinder /beaker) or collect water from spout in a measuring cylinder /beaker (1)</p>	<p>give credit for other acceptable methods</p> <p>If no other marks scored then allow 1 mark for attempt to measure volume directly: e.g. fill copper tube with water, tip out and measure volume or measure dimension(s) of copper tube</p>	(3)

Question number	Answer	Additional guidance	Mark
2(a)(ii)	<p>recall and substitution (1)</p> $\text{density} = \frac{m}{V}$ <p>(density =) <math>\frac{0.058}{6.5 \times 10^{-6}}</math></p> <p>evaluation (1)</p> $8.9 \times 10^3 \text{ (kg/m}^3\text{)}$	<p>accept values that round to 8900 e.g. 8923(kg/m<sup>3</sup>) or 9000</p> <p>8.9 to any other power of ten gains 1 mark</p> <p>award full marks for correct answer without working.</p>	(2)

Question number	Answer	Additional guidance	Mark
2(b)(i)	<p>Rearrangement (and substitution) (1)</p> $c = \frac{1050}{0.058 \times 78}$ <p>evaluation (1)</p> $230 \text{ (J/kg } ^\circ\text{C)}$	$c = \frac{\Delta Q}{m \times \Delta\theta}$ <p>award 1 mark if 78 seen</p> <p>accept 232(J/kg °C)</p> <p>award full marks for correct answer without working.</p>	(2)

Question number	Answer	Additional guidance	Mark
2(b)(ii)	<p>any two of the following</p> <p>reduce heat loss from water/insulate beaker/add cover (1)</p> <p>make the temperature rise larger/use a larger piece of copper/ use a smaller amount of water (1)</p> <p>(use)a stirrer (1)</p> <p>account for heat gained by glass beaker (1)</p> <p>transfer the hot copper faster (1)</p> <p>use a different heating method (1)</p> <p>measure the temperature of the boiling water (1)</p>	<p>ignore more accurate measurements e.g. thermometer, balance etc.</p> <p>ignore taking repeats</p> <p>start with colder water</p>	(2)

**Total marks for question 2= 9 Physics**



Question number	Answer	Additional guidance	Mark
3(a)	(upward) force increases with speed (1)  relationship is non-linear (1)	allow reverse argument  changing rate / increases exponentially/ initially no upward force (until 1000 turns per minute)	(2)

Question number	Answer	Additional guidance	Mark
3(bi)	recall and substitution into (1) $gpe = m \times g \times h$  (gpe) = $4.5 \times 10 \times 20$  evaluation (1)  900(J)	allow 90(J) for 1 mark  award full marks for the correct answer without working	(2)

Question number	Answer	Additional guidance	Mark
3bii	900(J)	allow ecf from bi	(1)

Question number	Answer	Additional guidance	Mark
3biii	recall and substitution (1)  power = work done / time taken  (power = ) $900 / 4$  evaluation (1) 200 (W)	allow ecf from bi or bii  accept 230(W), 225(W)  award full marks for the correct answer without working	(2)

**Total marks for question 3= 7**

Question number	Answer	Additional guidance	Mark
4 (a) (i)	rub (the balloon) (1) with a piece of cloth/hair/fur (1)	use friction allow on any insulated object	(2)

Question number	Answer	Additional guidance	Mark
4 (a) (ii)	B Negative charge has been added to the balloon  A is incorrect removing negative charge would make the balloon positively charged. C and D are incorrect because positive charge cannot be moved		(1)

Question number	Answer	Additional guidance	Mark
4(a)(iii)	an explanation linking:  method of handling balloons without discharging them (1)  bring balloons near to each other (1)  observation of repulsion (1)	hang balloons up by their strings    they/balloons will push away (from each other)	(3)

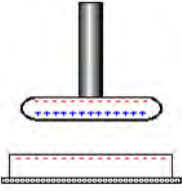
Question number	Answer	Additional guidance	Mark
4 (b) (i)	<p>B</p>  <p>A and D are incorrect because a negative charge cannot induce a negative charge C is incorrect because the disc is insulated so negative charge cannot be removed</p>		(1)

Question number	Answer	Additional guidance	Mark
4 (b) (ii)	<p>an explanation linking:</p> <p><u>electrons</u> / <u>negative</u> charges move/ flow/transfer (1)</p> <p>from the metal disc / to the student / to earth/ground (1)</p>	<p>reject positive charge moving for first mark</p> <p>accept lose electrons</p>	(2)

Question number	Answer	Additional guidance	Mark
4(b)(iii)	<p>at least three straight lines joining disc and plastic (1)</p> <p>arrow(s) from disc towards plastic (1)</p>	<p>judge by eye ignore curved lines at edge</p> <p>do not award mark if there are arrows in both directions</p>	(2)

**Total marks for Question 4 = 11**

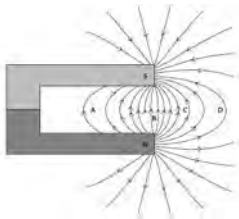
Question number	Answer	Mark
5(a)(i)	<p>B</p>  <p>A, C and D are in the areas where the field lines are further apart and the field is weaker</p>	(1)

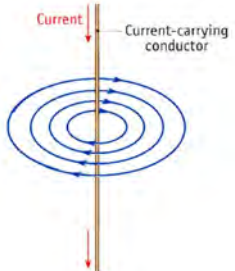
Question number	Answer	Additional guidance	Mark
5 (b)	 <p>at least two concentric circles (1)</p> <p>arrows correct (1)</p>	separation of the circles is increasing	(2)

Question number	Answer	Additional guidance	Mark
5 ci	<p>substitution (1)</p> <p>( <math>F = </math>) <math>1.2 \times 2.5 \times 0.06</math></p> <p>evaluation (1)</p> <p>0.18 (N)</p>	award full marks for the correct answer without working	(2)

Question number	Answer	Additional guidance	Mark
5(c)(ii)	<p>a description to include</p> <p>first finger, second finger and thumb (of left-hand) held mutually perpendicular (1)</p> <p>first finger (is in the direction of) magnetic field OR second finger ( is in the) direction of) current (1)</p> <p>thumb ( is in the) direction of force / motion (1)</p>	<p>award 1 mark for attempt at mutually perpendicular shown in a diagram</p> <p>diagram relating thumb and fingers to correct quantities at right angle gains 3 marks</p>	(3)

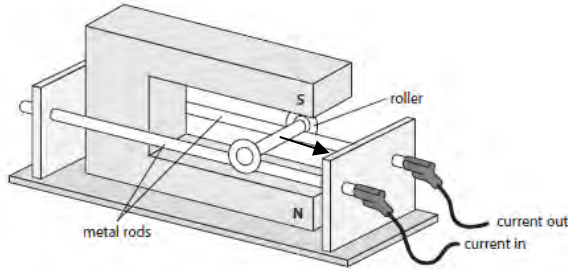
Question number	Answer	Additional guidance	Mark
5(c)(iii)	 <p>arrow from roller towards contacts (1)</p>		(1)

Total marks for question5 =9

Question number	Answer	Additional guidance	Mark
6 (a)(i)	50.0 to 55.0 (mm) inclusive		(1)

Question number	Answer	Additional guidance	Mark
6 (a)(ii)	a description including  note the original length (1)  note the final length and subtract (1)		(2)

Question number	Answer	Additional guidance	Mark
6 (a)(iii)	any two from:  use a ruler with a smaller/millimetre divisions (1)  use interim values of weight (1)  add more weights ( to increase the range) (1)  move the ruler closer to the spring (1)  use of pointer (1)  repeat <b>and</b> average (1)	ignore more accurate  add fixed values of weights    eye level / no parallax	(2)

Question number	Answer	Additional guidance	Mark
6(a)(iv)	the coils are {pushed together /touching} (1)  or  spring is fully compressed /cannot be made shorter (1)		(1)

Question number	Answer	Additional guidance	Mark
6 (b)	<p>recall and substitution (1)</p> $0.5 = k \times 13 \times 10^{-3}$ <p>rearrangement (1)</p> $\frac{0.5}{13 \times 10^{-3}}$ <p>evaluation (1)</p> <p>38 (N/m)</p>	$k = \frac{F}{x}$ <p>allow 38.5 (N/m) or 38.46 (N/m) or 39 (N/m)</p> <p>0.04/0.038 (N/m) gains 2 marks</p> <p>2958 (N/m) gains 1 mark (<math>x^2</math> used in equation)</p> <p>award full marks for the correct answer without working</p>	(3)

Question number	Answer	Additional guidance	Mark
6 (c)	<p>substitution (1)</p> $0.14 = \frac{1}{2} \times 175 \times x^2$ <p>rearrangement for <math>x^2</math> (1)</p> $(x^2 =) \frac{0.14 \times 2}{175} \text{ or } \frac{0.14}{0.5 \times 175}$ <p>evaluation (1)</p> <p>0.04 (m)</p>	<p>substitution and rearrangement in either order</p> $x^2 = \frac{E}{\frac{1}{2} \times k}$ <p><math>1.6 \times 10^{-3}</math> seen gains 2 marks</p> <p>0.02(m) gains 2 marks</p> <p>0.028 gains 1 mark</p> <p>award full marks for the correct answer without working</p>	(3)

**Total marks for question 6 = 12**

Question number	Answer	Mark
7(a)(i)	<p>C</p>  <p>A and B are incorrect because there is no current when the magnet is stationary in the coil. D is incorrect because there is always a current when the magnet is moving in the coil</p>	(1)

Question number	Answer	Additional guidance	Mark
7 (a)(ii)	<p>any two from</p> <p>moving the magnet faster (1)</p> <p>using a stronger magnet (1)</p> <p>more turns/rotations on the coil (1)</p>	do not allow increase size of coil	(2)

Question number	Answer	Additional guidance	Mark
7 (b)	<p>an explanation linking in a logical order any four of the following: -</p> <p>(alternating) current produces (changing) magnetic field (around coil)(1)</p> <p>the coil is in a magnetic field (of fixed magnets) (1)</p> <p>(varying current in magnetic field) produces a force (1)</p> <p>the force on the coil /cone (continuously) changes direction (1)</p> <p>the paper cone /coil vibrates/ moves to and fro (1)</p>	<p>magnetic fields interact</p> <p>making the air molecules ( in the cone) vibrate</p>	(4)



Question number	Answer	Additional guidance	Mark
7 (c) (i)	{ step up/increase} (output) voltage or { stepdown/ decrease} (output) current		(1)

Question number	Answer	Additional guidance	Mark
7(c)(ii)	substitution (1) $\frac{230}{V_s} = \frac{18}{26}$ rearrangement (1) $(V_s =) \frac{230 \times 26}{18}$ evaluation (1) 330(V)	substitution and re-arrangement in either order  allow 332 (.2) (V) allow answers between 322 (V) and 333 (V) where candidates have truncated an intermediate calculation  159.2 (V), 160 (V) gains 1 mark  award full marks for the correct answer without working	(3)

**Total marks for question 7 = 11**

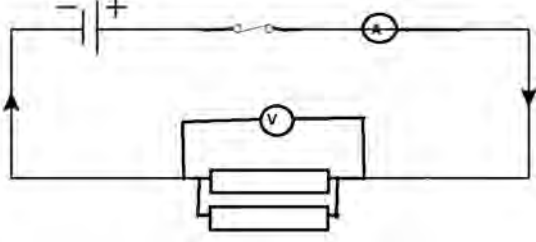
Question number	Answer	Additional guidance	Mark
8(a)(i)	 <p>voltmeter in parallel across resistor (1)</p> <p>second resistor in parallel (1)</p>		(2)

Question number	Answer	Additional guidance	Mark
8(a)(ii)	<p>potential difference/ voltage (drop across resistors in parallel) (1)</p> <p>current (in the circuit) (1)</p>	<p>voltmeter reading</p> <p>ammeter reading</p>	(2)

Question number	Answer	Additional guidance	Mark
8(a)(iii)	1 ( $\Omega$ )	one (ohm)	(1)

Question number	Answer	Additional guidance	Mark
8(a)(iv)	<p>Comments to include:</p> <p>the (overall) resistance decreases as the number of resistors (in parallel) increases (1)</p> <p>the relationship is non-linear (1)</p> <p>any two relevant values from the graph (1)</p>	<p>decreases at a decreasing rate</p> <p>the relationship is inversely proportional scores first 2 marks</p>	(3)

Question number	Answer	Additional guidance	Mark
<b>8(b) (i)</b>	recall and substitution (1)  $V = 0.20 \times 15$  evaluation (1) 3 (V)	7(V) gains 1 mark (use of 15 + 20)  award full marks for the correct answer without working	<b>(2)</b>

Question number	Answer	Additional guidance	Mark
<b>8(b) (ii)</b>	addition and substitution (1)  (P=) $0.20^2 \times 35$  evaluation (1) 1.4 (W)	award full marks for the correct answer without working	<b>(2)</b>

**Total mark for question 8 = 12 marks**

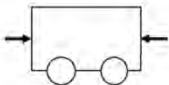
Question number	Answer	Mark
9(a)	<p>B</p>  <p>A, C and D are incorrect because they all show a resultant force which would cause the trolley to accelerate</p>	(1)

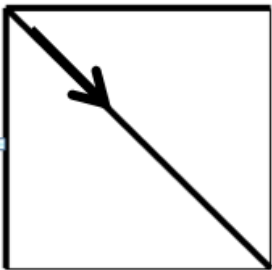
Question number	Answer	Additional guidance	Mark
9(b)	<p>Scale drawing</p> <p>two lines at right angles (1)</p> <p>a correct scaling (for example 10kN equivalent to 1 cm) / a completed square or triangle(1)</p> <p>diagonal in correct direction (1)</p> <p>28 kN (1)</p>	 <p>judge by eye</p> <p>accept answers from 25 kN to 30 kN</p> <p>accept use of Pythagoras</p> <p>award full marks for correct answer without working.</p>	(4)

Question number	Indicative content	Mark
9c*	<p>Answers will be credited according to candidate's deployment of knowledge and understanding of the material in relation to the qualities and skills outlined in the generic mark scheme.</p> <p>The indicative content below is not prescriptive, and candidates are not required to include all the material which is indicated as relevant. Additional content included in the response must be scientific and relevant.</p> <p style="text-align: center;">A01</p> <p><b>Horizontal forces</b></p> <ul style="list-style-type: none"> <li>• tension in the string/pull of the string</li> <li>• tension is one of the horizontal forces acting on the wooden block</li> <li>• friction between the table and the wooden block</li> <li>• friction acts in the opposite direction to the tension</li> <li>• friction opposes motion</li> <li>• the force due to friction is equal to the force provided by the tension</li> <li>• the forces are balanced /equal and opposite</li> <li>• no resultant force, so the block moves at a constant (horizontal) velocity</li> </ul> <p><b>Vertical forces</b></p> <ul style="list-style-type: none"> <li>• (normal) reaction (force) upwards between the table and the wooden block</li> <li>• contact force</li> <li>• weight of block downwards</li> <li>• the weight (force of gravity) and the (normal) reaction are equal and opposite / balanced</li> <li>• the block does not move up or down</li> <li>• tension caused by the force due to gravity on the weight</li> <li>• vertical forces on the block do not affect horizontal velocity.</li> </ul> <p>labels on the diagram should be considered when marking  candidates do not have to indicate the forces as horizontal and vertical</p>	(6)

Level	Mark	Descriptor
	0	<ul style="list-style-type: none"> <li>No rewardable material.</li> </ul>
Level 1	1-2	<ul style="list-style-type: none"> <li>Demonstrates elements of physics understanding, some of which is inaccurate. Understanding of scientific ideas lacks detail. (AO1)</li> <li>Presents an explanation with some structure and coherence. (AO1)</li> </ul>
Level 2	3-4	<ul style="list-style-type: none"> <li>Demonstrates physics understanding, which is mostly relevant but may include some inaccuracies. Understanding of scientific ideas is not fully detailed and/or developed. (AO1)</li> <li>Presents an explanation that has a structure which is mostly clear, coherent and logical. (AO1)</li> </ul>
Level 3	5-6	<ul style="list-style-type: none"> <li>Demonstrates accurate and relevant physics understanding throughout. Understanding of the scientific ideas is detailed and fully developed. (AO1)</li> <li>Presents an explanation that has a well-developed structure which is clear, coherent and logical. (AO1)</li> </ul>

Level	Mark	Additional Guidance	General additional guidance – the decision within levels  e.g. - At each level, as well as content, the scientific coherency of what is stated will help place the answer at the top, or the bottom, of that level.
	0	No rewardable material.	
Level 1	1–2	<u>Additional guidance</u>  Elements of physics present i.e. isolated knowledge of principles <b>two</b> unconnected statements from any section	<u>Possible candidate responses</u>  contact force  weight pulls block  friction  tension in string  weight acts downward  reaction
Level 2	3–4	<u>Additional guidance</u>  Some knowledge of principles with a logical connection made in one section and statement from the other section  OR  Detailed knowledge of principles with logical connections made in one section	<u>Possible candidate responses</u>  There is friction between the table and the block and this opposes motion    weight of block acts downwards
Level 3	5–6	<u>Additional guidance</u>  Detailed knowledge of principles with logical connections made in one section and statement from the other section	<u>Possible candidate responses</u>  Friction and tension are equal and opposite there is no resultant /no acceleration    The weight (of the block) and the(normal) reaction are equal and opposite

**Total marks for question 9 = 11**

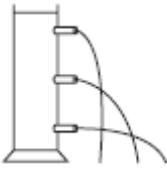
Question number	Answer	Mark
10(a)	<p>C</p>  <p>A,B and D are incorrect because pressure increases with depth</p>	(1)

Question number	Answer	Additional guidance	Mark
(b) (i)	<p>substitution (1)</p> $(p) = 1000 \times 10 \times 0.200$ <p>evaluation of pressure difference (1)</p> <p>2000</p> <p>final evaluation (1)</p> <p>103000 (Pa)</p>	<p>accept e.c.f for addition of atmospheric pressure seen for 1mark</p> <p>award 1 mark for selecting correct equation if no other mark awarded</p> <p>award full marks for correct answer without working.</p>	(3)



Question number	Answer	Additional guidance	Mark
10(b)(ii)	an explanation linking use of $P = h \times \rho \times g$ (1)  no area in the equation (1)	P /pressure, $\rho$ /density (and g /gravitational field strength) are constant/the same  Area does not affect result h /height of water is independent of area  P, $\rho$ , and g are all constant gains 2 marks	(2)

Question number	Indicative content	Mark
10(c) *	<p>Answers will be credited according to candidate's deployment of knowledge and understanding of the material in relation to the qualities and skills outlined in the generic mark scheme.</p> <p>The indicative (example) content below is not prescriptive and candidates are not required to include the material which is indicated as relevant. Additional content included in the response must be scientific and relevant.</p> <p style="text-align: center;">A02</p> <p><b>Pressure</b></p> <ul style="list-style-type: none"> <li>• difference in pressure between top and bottom of boat</li> <li>• top pressure is atmospheric</li> <li>• pressure on bottom of boat atmospheric plus that due to depth of water.</li> </ul> <p><b>Unloaded boat</b></p> <ul style="list-style-type: none"> <li>• density of boat less than density of water</li> <li>• floating objects are partially immersed</li> <li>• floating objects displace fluid / water</li> <li>• upthrust is due to the difference in pressure</li> <li>• upthrust is equal to the weight of the boat</li> <li>• upthrust is equal to the weight of fluid / water displaced</li> </ul> <p><b>Boat with load</b></p> <ul style="list-style-type: none"> <li>• the weight/density of the boat increases because of the load added</li> <li>• more upthrust is needed to balance the extra weight of the boat</li> <li>• more water has to be displaced to provide the upthrust</li> <li>• when the boat floats lower in the water it displaces more water</li> <li>• the weight of water displaced is the upthrust and is equal to the weight of the boat</li> </ul>	(6)

<b>Level</b>	<b>Mark</b>	<b>Descriptor</b>
	0	No rewardable material.
Level 1	1–2	The explanation attempts to link and apply knowledge and understanding of scientific ideas, flawed or simplistic connections made between elements in the context of the question. Lines of reasoning are unsupported or unclear. (AO2)
Level 2	3–4	The explanation is mostly supported through linkage and application of knowledge and understanding of scientific ideas, some logical connections made between elements in the context of the question. Lines of reasoning mostly supported through the application of relevant evidence. (AO2)
Level 3	5–6	The explanation is supported throughout by linkage and application of knowledge and understanding of scientific ideas, logical connections made between elements in the context of the question. Lines of reasoning are supported by sustained application of relevant evidence. (AO2)

Level	Mark	Additional Guidance	General additional guidance – the decision within levels  e.g. - At each level, as well as content, the scientific coherency of what is stated will help place the answer at the top, or the bottom, of that level.
	0	No rewardable material.	
Level 1	1–2	<u>Additional guidance</u>  Elements of physics present i.e. isolated knowledge of principles <b>two</b> unconnected statements from any section	<u>Possible candidate responses</u>  pressure difference  upthrust  water displaced  displacement  floating
Level 2	3–4	<u>Additional guidance</u>  Some knowledge of principles with a logical connection made in one section and statement from one other section	<u>Possible candidate responses</u>  upthrust and weight are balanced /upthrust is equal to the weight of the boat  when load added upthrust increases  difference in pressure between the top and bottom of the boat
Level 3	5–6	<u>Additional guidance</u>  Detailed knowledge of principles with logical connections made in two sections.	<u>Possible candidate responses</u>  upthrust is equal to the weight of water displaced.  when load is added, weight increases more water is displaced

**Total marks for question 10 = 12**