



Cambridge IGCSE™ (9–1)

BIOLOGY**0970/22**

Paper 2 Multiple Choice (Extended)

May/June 2020**45 minutes**

You must answer on the multiple choice answer sheet.

You will need: Multiple choice answer sheet
Soft clean eraser
Soft pencil (type B or HB is recommended)

INSTRUCTIONS

- There are **forty** questions on this paper. Answer **all** questions.
- For each question there are four possible answers **A, B, C** and **D**. Choose the **one** you consider correct and record your choice in soft pencil on the multiple choice answer sheet.
- Follow the instructions on the multiple choice answer sheet.
- Write in soft pencil.
- Write your name, centre number and candidate number on the multiple choice answer sheet in the spaces provided unless this has been done for you.
- Do **not** use correction fluid.
- Do **not** write on any bar codes.
- You may use a calculator.

INFORMATION

- The total mark for this paper is 40.
- Each correct answer will score one mark. A mark will not be deducted for a wrong answer.
- Any rough working should be done on this question paper.

This document has **16** pages. Blank pages are indicated.



- 1 The diagram shows what happened in an experiment with plant seedlings.

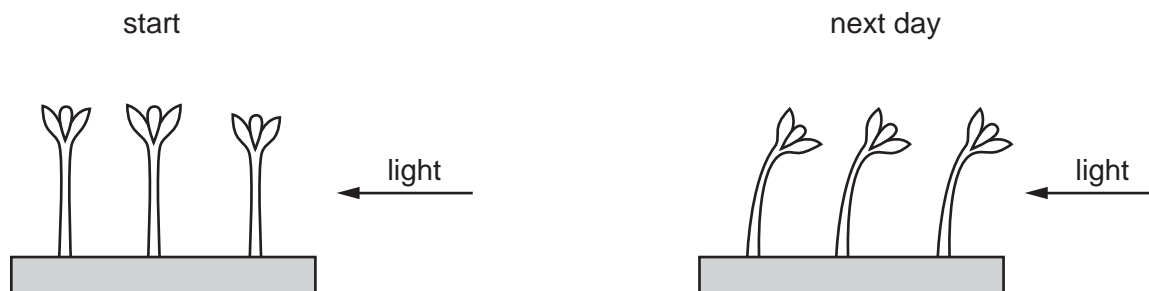

Which characteristic of living things made the seedlings grow towards the light?

- A excretion
 - B nutrition
 - C respiration
 - D sensitivity
- 2 A rat has the scientific name *Rattus rattus*.

What do the two parts of this name refer to?

- A genus and species
- B kingdom and genus
- C kingdom and species
- D variety and genus

- 3 The diagram shows a plant cell.

A biologist wants to find out the number of chromosomes it contains.

Which labelled part should be examined more closely?

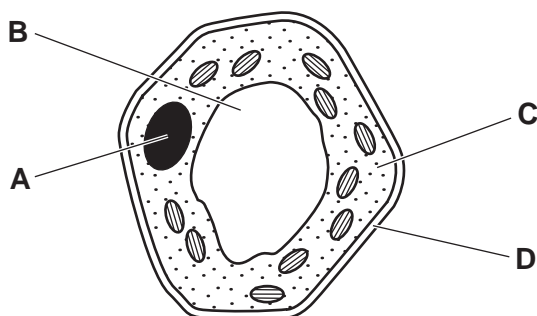

3

- 4 The diagram shows a human liver cell.

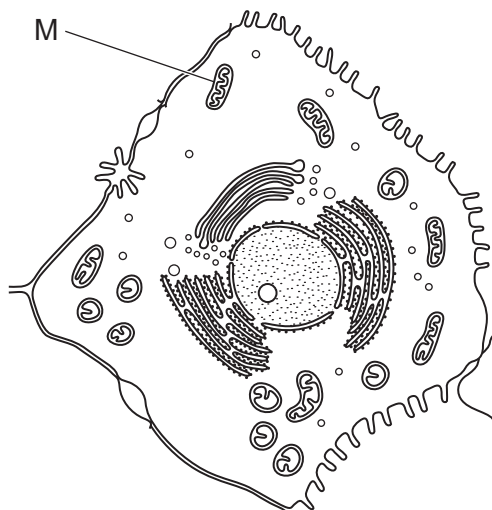

The length of structure M on the diagram is 6 mm.

The magnification of the diagram is $\times 2000$.

What is the actual length of M?

- A** $0.03\ \mu\text{m}$ **B** $3\ \mu\text{m}$ **C** $333\ \mu\text{m}$ **D** $12000\ \text{mm}$
- 5 Which diagram shows the appearance of a plant cell several minutes after it has been placed in a concentrated solution of sugar?

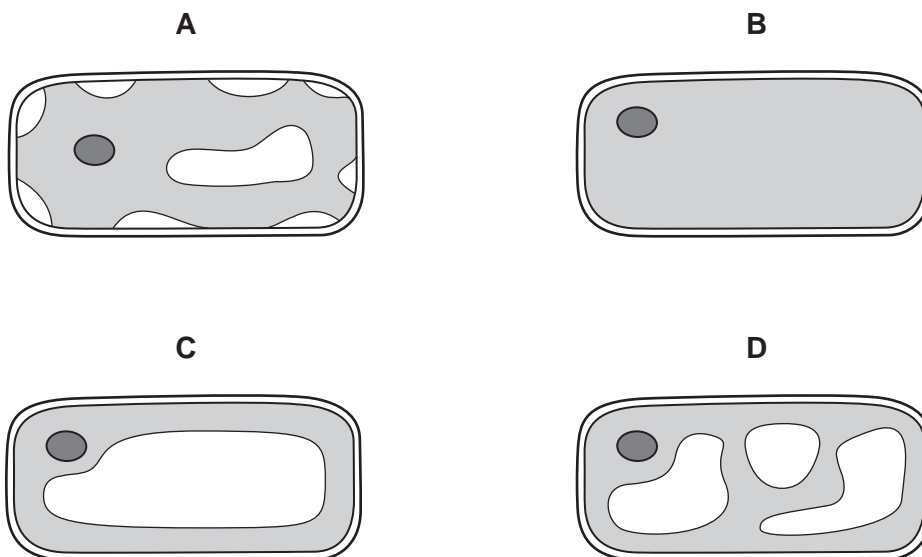

4

- 6 An uncooked piece of potato was placed in a solution. After two hours the size of the piece of potato had decreased.

Which row explains why this has happened and how the potato cells have changed?

	water potential		potato cells become
	potato cells	external solution	
A	higher	lower	flaccid
B	higher	lower	turgid
C	lower	higher	flaccid
D	lower	higher	turgid

- 7 The diagram shows a section of DNA, with four bases identified on one strand.

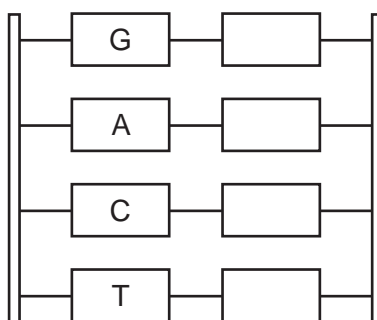

Which sequence of bases would be on the other strand, starting from the top?

- A** AGTC **B** CTGA **C** GACT **D** TCAG
- 8 Which food-testing solution shows a positive result when it turns from blue to purple?
- A** Benedict's solution
B biuret solution
C ethanol
D iodine solution

5

9 The diagram shows the four types of human tooth.

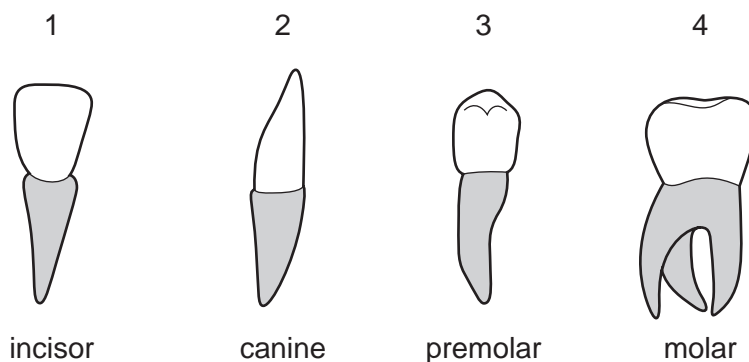

Which teeth are used for grinding food?

- A** 1 and 2 **B** 2 and 3 **C** 3 and 4 **D** 4 and 1

10 Enzymes function best at their optimum temperature.

Which statement describes the effect on an enzyme of increasing the temperature to the enzyme's optimum temperature?

- A** There are more frequent successful collisions.
B The kinetic energy of the enzymes decreases.
C The enzymes begin to lose their complementary shape.
D The rate at which enzyme-substrate complexes form is reduced.

11 The diagram shows how the rate of photosynthesis varies with light intensity.

The four curves show different conditions of temperature and carbon dioxide concentration.

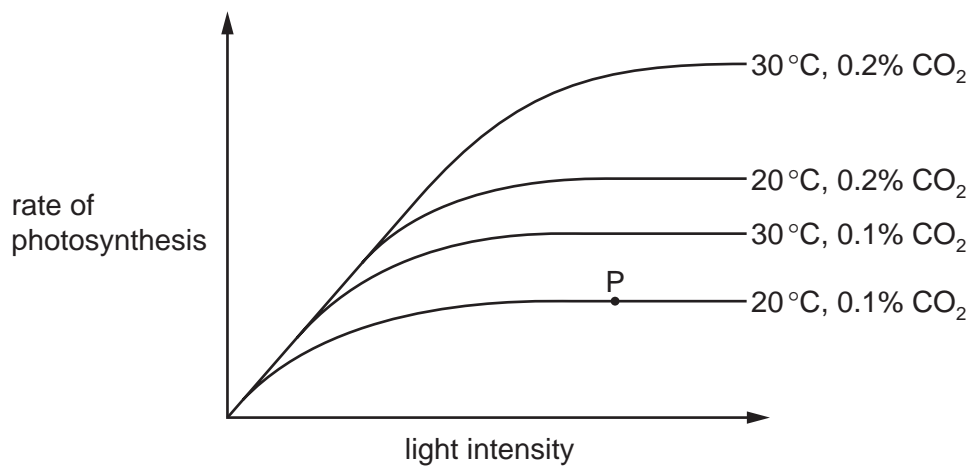

What limits the rate of photosynthesis at point P?

	light intensity	carbon dioxide concentration	temperature	
A	✓	✓	✗	key ✓ = yes ✗ = no
B	✓	✗	✗	
C	✗	✓	✓	
D	✗	✗	✓	

12 The diagram shows a plant cell.

In which part of the cell does photosynthesis occur?

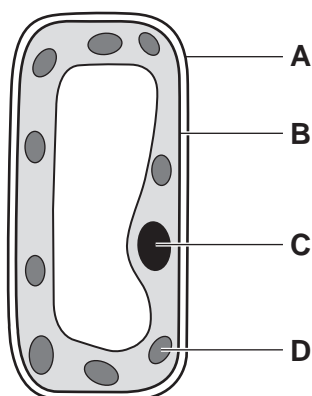

13 The graph shows the effect of pH on the activity of an enzyme.

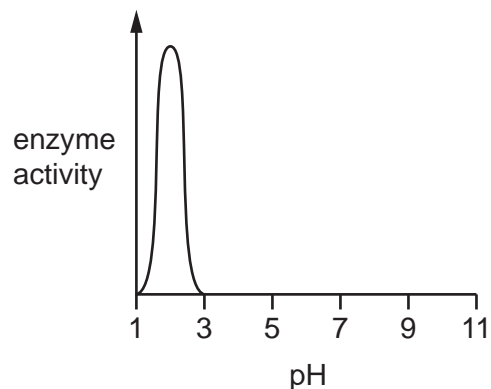

In which part of the alimentary canal would this enzyme be **most** active?

- A large intestine
 - B mouth
 - C small intestine
 - D stomach
- 14 The diagram shows the structure of a villus. The arteriole, capillary, lacteal and venule are labelled with letters.

Which letter shows where nutrients are absorbed into the blood?

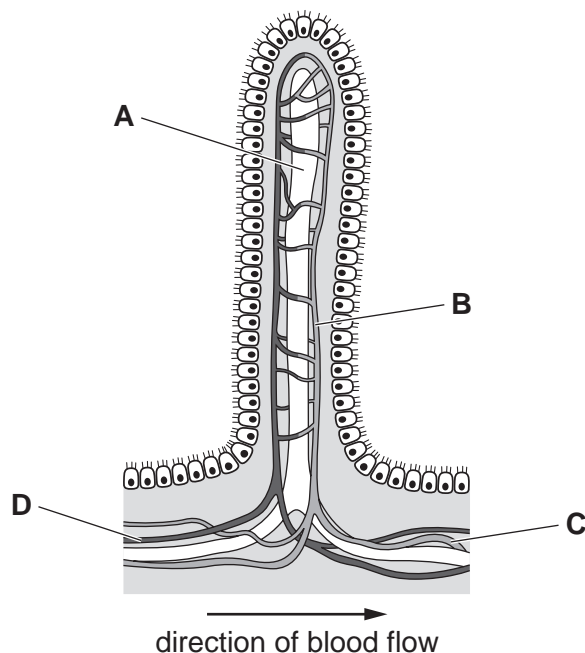

15 Which change increases the rate of water uptake by the roots of a plant?

- A decrease in evaporation of water from mesophyll cells
- B decrease in length of root hairs
- C decrease in water potential of root hair cells
- D decrease in water potential of soil water

16 Dodder is a plant that grows on other plants called the hosts. The dodder plant connects to the host's vascular bundles.

The dodder plant does not have green leaves or roots.

What correctly describes the regions for translocation?

	host leaves	dodder
A	sink	sink
B	sink	source
C	source	sink
D	source	source

17 The diagrams show the single circulation of a fish and the double circulation of a mammal.

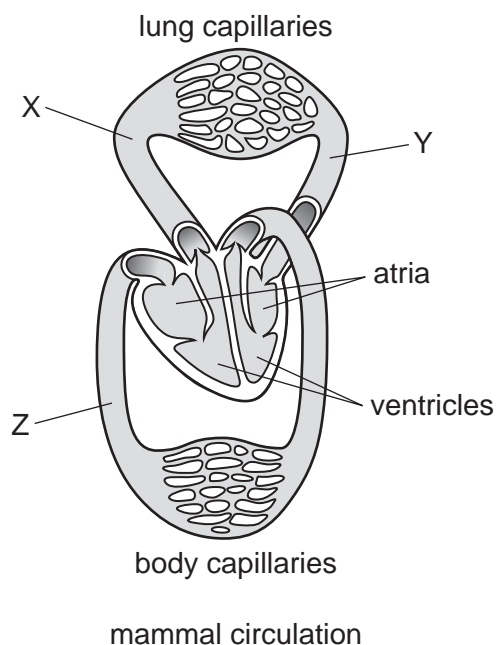
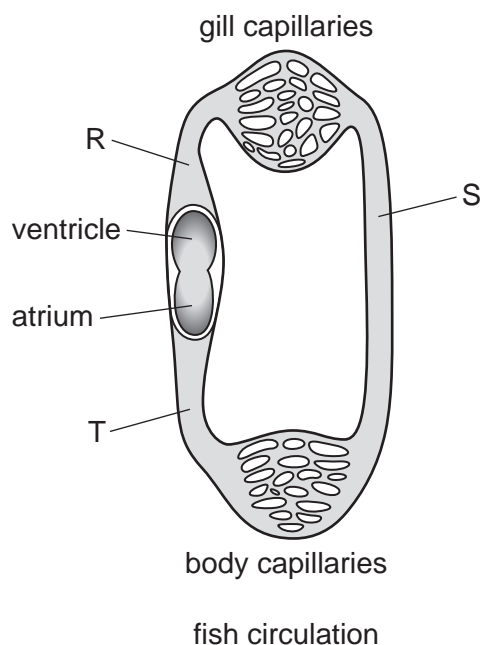

Which letters represent areas of oxygenated blood?

- A R and X
- B S and Y
- C T and Y
- D T and Z

18 The diagram shows the human heart and main blood vessels.

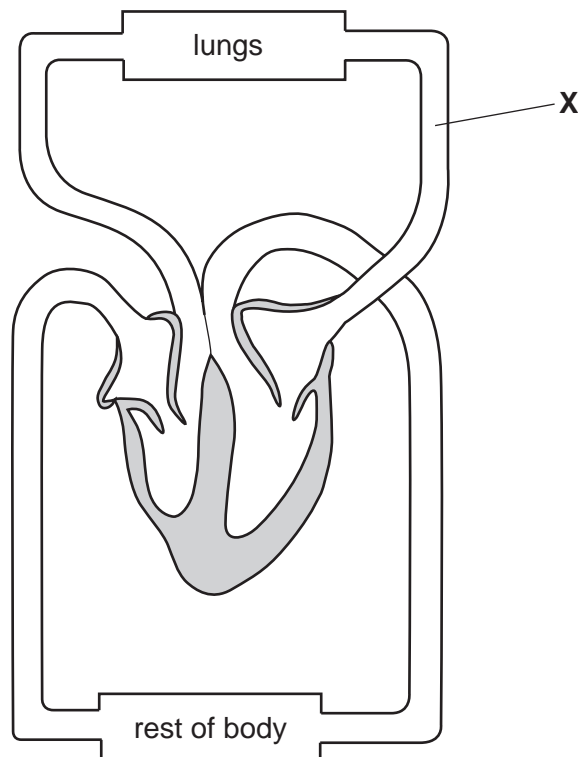

What is the blood vessel labelled X?

- A aorta
- B pulmonary artery
- C pulmonary vein
- D vena cava

19 The following are statements about immunity.

- 1 The transfer of antibodies from mother to baby in breast milk is an example of passive immunity.
- 2 Passive immunity results in long term immunity because of the production of memory cells.
- 3 Active immunity is gained after vaccination with antigens.

Which statements are correct?

- A 1, 2 and 3
- B 1 and 2 only
- C 1 and 3 only
- D 2 and 3 only

20 What is the site of gas exchange in humans?

- A nose
- B alveoli
- C bronchus
- D trachea

21 The substances listed are associated with aerobic respiration.

- 1 carbon dioxide
- 2 glucose
- 3 oxygen
- 4 water

Which substances are the products of aerobic respiration?

- A 1 and 3
- B 1 and 4
- C 2 and 3
- D 3 and 4

22 The formula C_2H_5OH represents a chemical produced during anaerobic respiration.

What is this chemical?

- A alcohol
- B glucose
- C glycogen
- D lactic acid

23 What is filtered out of the blood in the glomerulus into the kidney tubule?

	glucose	urea	
A	✓	✓	key ✓ = yes X = no
B	✓	X	
C	X	✓	
D	X	X	

- 24 Which responses occur in the iris of the eye when a person walks from a brightly lit area to a dimly lit area?

	circular muscle	radial muscle
A	contract	contract
B	contract	relax
C	relax	contract
D	relax	relax

- 25 Which glands are endocrine glands?

- A** adrenal, pancreas, testes
- B** adrenal, ovaries, salivary
- C** ovaries, sweat, testes
- D** pancreas, salivary, sweat

- 26 What are the effects of insulin and adrenaline on the concentration of blood glucose?

	effect of insulin on blood glucose concentration	effect of adrenaline on blood glucose concentration
A	decreases	decreases
B	decreases	increases
C	increases	decreases
D	increases	increases

- 27 Asexual reproduction can be used to produce crops.

Why might a disease be likely to spread throughout the whole crop?

- A** crop plants are genetically different
- B** crop plants are genetically identical
- C** many offspring are produced
- D** offspring are produced quickly

28 In a comparison between the processes of artificial insemination (AI) and in vitro fertilisation (IVF), which statement applies to IVF only?

- A Human egg cells are harvested from the ovary.
- B Donated sperm cells are used to fertilise the egg cells.
- C Childless couples are given the opportunity to have a child of their own.
- D Fertilisation occurs inside the body of the female.

29 The diagram shows half a flower. There is a description of each numbered part.

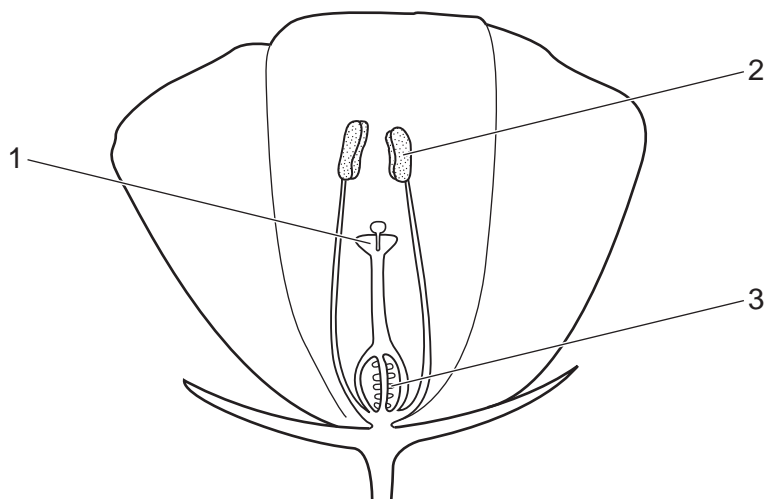

- 1 the stigma which receives pollen from insects
- 2 the anther which produces smooth and light pollen grains
- 3 the ovule where fertilisation occurs when the male and female nuclei fuse

Which descriptions are correct for an insect-pollinated flower?

- A 1 only
- B 1 and 3 only
- C 2 and 3 only
- D 1, 2 and 3

30 What is a diploid nucleus?

- A a nucleus containing one set of chromosomes
- B a nucleus containing two sets of chromosomes
- C a nucleus with one double helix of DNA
- D a nucleus with two genes

31 Which statement about meiosis is correct?

- A At the end of meiosis a zygote has been produced.
- B During meiosis the haploid number is halved in the daughter cells.
- C Meiosis is reduction division in which diploid daughter cells are produced.
- D The parent cell contains twice as many chromosomes as each daughter cell.

32 The diagram shows the inheritance of height in pea plants.

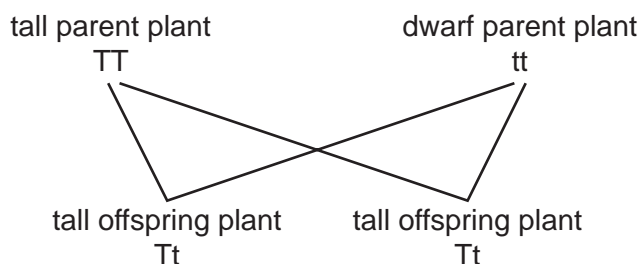

Which plants have a heterozygous genotype?

- A both parent plants
- B dwarf parent plant only
- C both offspring plants
- D tall parent plant only

33 The graph shows the masses of two different types of tomato.

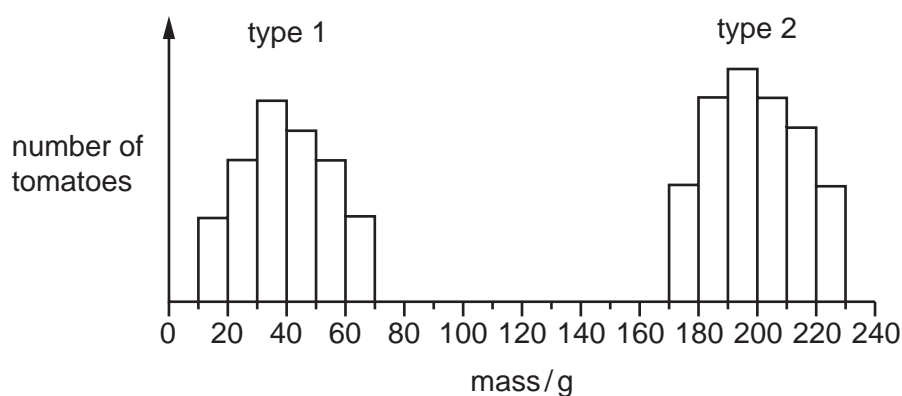

What can be concluded from the graph?

- A Genes do not affect the mass of tomatoes.
- B Type 1 tomatoes show continuous variation.
- C Type 2 tomatoes are sometimes smaller than type 1 tomatoes.
- D Type 2 tomatoes show discontinuous variation.

- 34 Which adaptation may be present in a xerophyte?
- A leaves with small surface area and large numbers of stomata
 - B little or no xylem tissue and leaves with large surface area
 - C stomatal hairs and rolled leaves
 - D thin or no cuticle and deep roots

- 35 The diagram shows a food chain in a rock pool.

seaweed → whelks → crabs → seagulls

What will happen if the number of secondary consumers increases?

There will be

- A fewer crabs.
 - B fewer seagulls.
 - C fewer whelks.
 - D less seaweed.
- 36 What is defined as 'all of the populations of different species in an ecosystem'?
- A community
 - B environment
 - C habitat
 - D trophic level
- 37 What is the role of anaerobic respiration in bread-making?
- A to produce alcohol to flavour the bread
 - B to produce gas to make the bread rise
 - C to release enough energy to bake the bread
 - D to release enough lactic acid to kill the yeast
- 38 A crop plant has been genetically modified to make it resistant to herbicides.
- Which is a possible disadvantage of introducing this new crop plant?
- A Loss of weeds reduces competition.
 - B Some weeds might become resistant to the herbicide.
 - C The crop plant is unharmed and produces a higher yield.
 - D The new gene will appear in new generations of the crop.

39 Which is a reason for using bacteria in biotechnology?

- A Bacteria are found inside the human body.
- B Bacteria do not become resistant to antibiotics.
- C Bacteria can make complex molecules.
- D Bacteria reproduce slowly.

40 When a river is polluted by fertiliser, the following processes may occur.

- 1 increased aerobic respiration of decomposers
- 2 increased growth of producers
- 3 decreased oxygen concentration in the water

What is the correct sequence for these processes?

- A 1 → 2 → 3 B 1 → 3 → 2 C 2 → 1 → 3 D 2 → 3 → 1

BLANK PAGE

Permission to reproduce items where third-party owned material protected by copyright is included has been sought and cleared where possible. Every reasonable effort has been made by the publisher (UCLES) to trace copyright holders, but if any items requiring clearance have unwittingly been included, the publisher will be pleased to make amends at the earliest possible opportunity.

To avoid the issue of disclosure of answer-related information to candidates, all copyright acknowledgements are reproduced online in the Cambridge Assessment International Education Copyright Acknowledgements Booklet. This is produced for each series of examinations and is freely available to download at www.cambridgeinternational.org after the live examination series.

Cambridge Assessment International Education is part of the Cambridge Assessment Group. Cambridge Assessment is the brand name of the University of Cambridge Local Examinations Syndicate (UCLES), which itself is a department of the University of Cambridge.