



**Cambridge International Examinations**  
Cambridge International General Certificate of Secondary Education

**CHEMISTRY**

**0620/13**

Paper 1 Multiple Choice (Core)

**May/June 2016**

**45 Minutes**

Additional Materials:      Multiple Choice Answer Sheet  
   Soft clean eraser  
   Soft pencil (type B or HB is recommended)



**READ THESE INSTRUCTIONS FIRST**

Write in soft pencil.

Do not use staples, paper clips, glue or correction fluid.

Write your name, Centre number and candidate number on the Answer Sheet in the spaces provided unless this has been done for you.

**DO NOT WRITE IN ANY BARCODES.**

There are **forty** questions on this paper. Answer **all** questions. For each question there are four possible answers **A, B, C** and **D**.

Choose the **one** you consider correct and record your choice in **soft pencil** on the separate Answer Sheet.

**Read the instructions on the Answer Sheet very carefully.**

Each correct answer will score one mark. A mark will not be deducted for a wrong answer.

Any rough working should be done in this booklet.

A copy of the Periodic Table is printed on page 16.

Electronic calculators may be used.

The syllabus is approved for use in England, Wales and Northern Ireland as a Cambridge International Level 1/Level 2 Certificate.

This document consists of **16** printed pages.

## 2

- 1 In which changes do the particles move further apart?



- A** W and X      **B** W and Z      **C** X and Y      **D** Y and Z
- 2 Chromatography experiments are carried out on four substances, P, Q, R and S.

The same solvent is used in each experiment.

The resulting chromatograms are shown below.

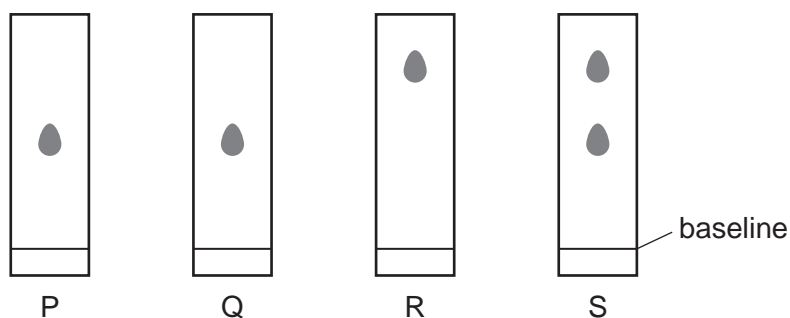

Which statement is **not** correct?

- A** P and Q are pure substances.  
**B** P and R are different substances.  
**C** R and S are pure substances.  
**D** S is a mixture of substances.
- 3 One of the instructions for an experiment reads as follows.

Quickly add 50 cm<sup>3</sup> of acid.

What is the best piece of apparatus to use?

- A** a burette  
**B** a conical flask  
**C** a measuring cylinder  
**D** a pipette

4 The structures of diamond and graphite are shown.

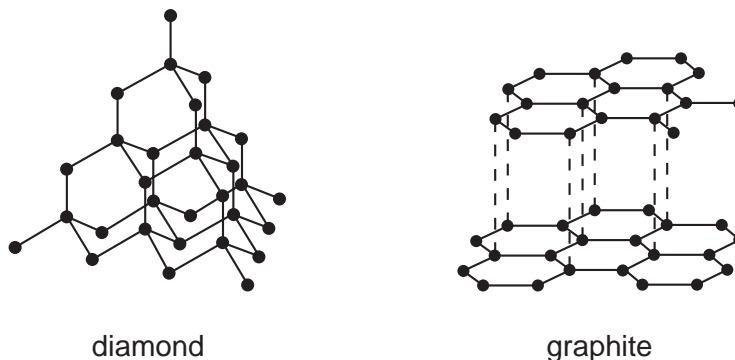

Which statement about diamond and graphite is **not** correct?

- A Diamond is used in cutting tools because the strong covalent bonds make it very hard.
- B Graphite acts a lubricant because of the weak bonds between the layers.
- C Graphite conducts electricity because the electrons between the layers are free to move.
- D Graphite has a low melting point because of the weak bonds between the layers.

5 The table shows the electronic structure of four atoms.

atom	electronic structure
W	2,8,1
X	2,8,4
Y	2,8,7
Z	2,8,8

Which two atoms combine to form a covalent compound?

- A** W and X      **B** W and Y      **C** X and Y      **D** X and Z

6 The table shows the atomic structure of four atoms.

Which atom is **not** a metal?

	electrons	neutrons	protons
<b>A</b>	18	22	18
<b>B</b>	19	20	19
<b>C</b>	19	21	19
<b>D</b>	20	20	20

## 4

7 Potassium, K, forms a compound with fluorine, F.

Which statements about this compound are correct?

- 1 The compound is ionic.
- 2 The formula of the compound is KF.
- 3 The compound is soluble in water.

**A** 1, 2 and 3      **B** 1 and 2 only      **C** 1 and 3 only      **D** 2 and 3 only

8 The equation shows the reaction between magnesium and sulfuric acid.

[ $A_r$ : H, 1; O, 16; Mg, 24; S, 32]

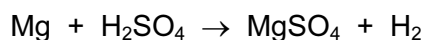

In this reaction, which mass of magnesium sulfate is formed when 6 g of magnesium react with excess sulfuric acid?

**A** 8                      **B** 24                      **C** 30                      **D** 60

9 The diagram shows an electrical cable.

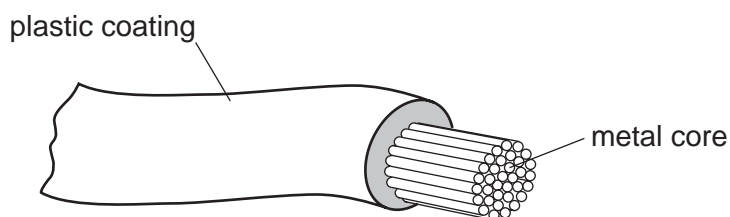

Which statement about the substances used is correct?

- A The coating is plastic because it conducts electricity well.
- B The core is copper because it conducts electricity well.
- C The core is copper because it is cheap and strong.
- D The core is iron because it is cheap and strong.

- 10 Electricity is passed separately through concentrated hydrochloric acid, concentrated aqueous sodium chloride and dilute sulfuric acid.

In which rows are the electrolysis products correctly named?

		cathode product	anode product
1	concentrated hydrochloric acid	hydrogen	chlorine
2	concentrated aqueous sodium chloride	sodium	chlorine
3	dilute sulfuric acid	hydrogen	oxygen

- A** 1, 2 and 3    **B** 1 and 2 only    **C** 1 and 3 only    **D** 2 and 3 only

- 11 The energy level diagram shows the energy of the reactants and products in a chemical reaction.

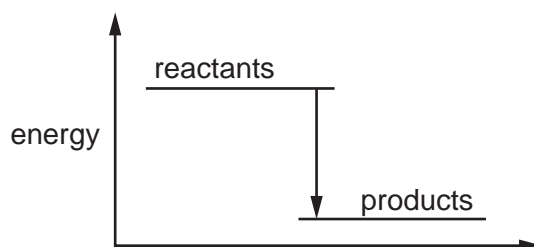

Which row correctly describes the energy change and the type of reaction shown?

	energy change	type of reaction
<b>A</b>	energy is given out to the surroundings	endothermic
<b>B</b>	energy is given out to the surroundings	exothermic
<b>C</b>	energy is taken in from the surroundings	endothermic
<b>D</b>	energy is taken in from the surroundings	exothermic

12 The diagram shows some properties that substances may have.

To which labelled part of the diagram does  $^{235}\text{U}$  belong?

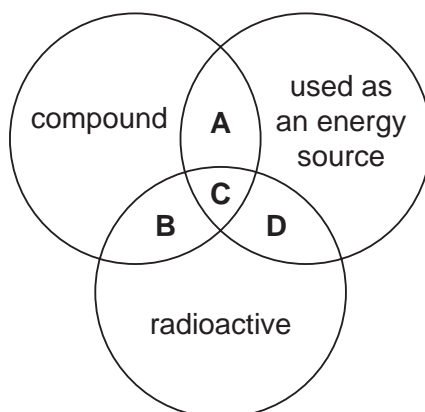

13 A liquid X reacts with solid Y to form a gas.

Which two diagrams show suitable methods for investigating the rate (speed) of the reaction?

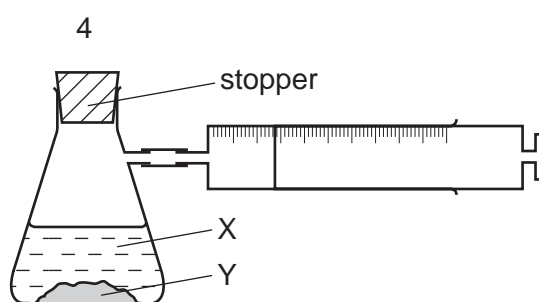
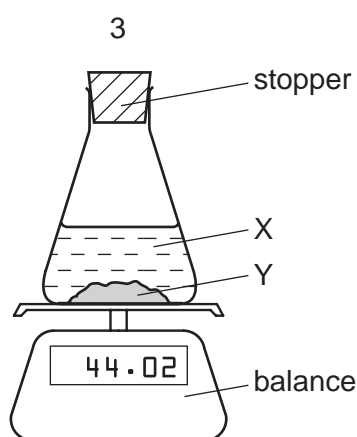
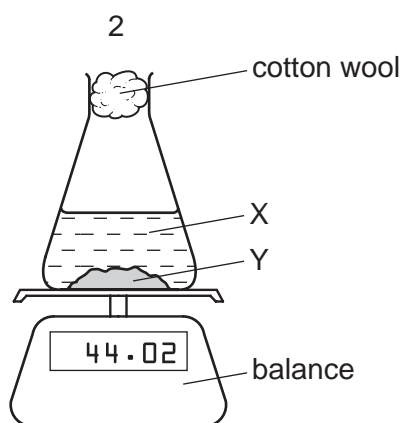
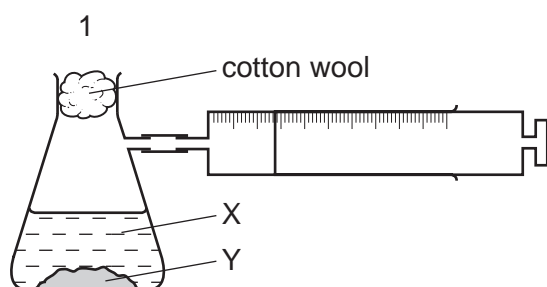

A 1 and 3

B 1 and 4

C 2 and 3

D 2 and 4

14 Magnesium is reacted with a dilute acid.

The hydrogen gas is collected and its volume measured.

The results are shown on the graph.

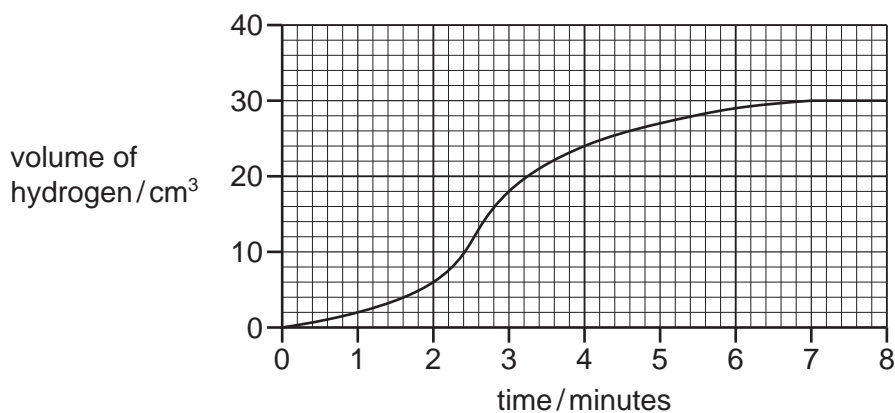

Between which times was the reaction fastest?

- A 0 and 1 minute
  - B 1 and 2 minutes
  - C 2 and 3 minutes
  - D 7 and 8 minutes
- 15 A violent reaction occurs when a mixture of chromium(III) oxide and aluminium is ignited with a magnesium fuse as shown.

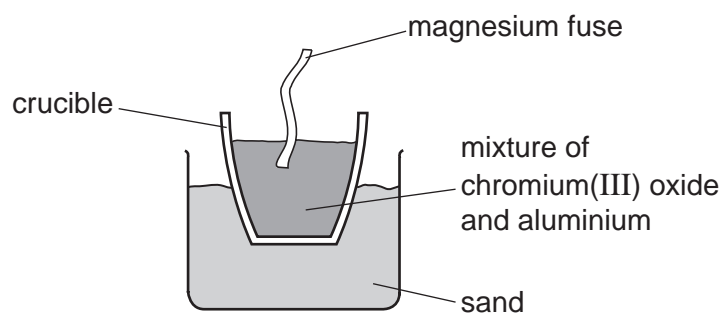

The equation for the reaction is shown.

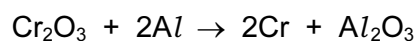

Which substance is oxidised in the reaction?

- A aluminium
- B aluminium oxide
- C chromium
- D chromium(III) oxide





19 Salts can be made by adding different substances to dilute hydrochloric acid.

For which substance could any excess **not** be removed by filtration?

- A copper(II) oxide
- B magnesium
- C sodium hydroxide
- D zinc hydroxide

20 A solution containing substance X was tested. The table shows the results.

test	result
flame test	lilac colour
acidified silver nitrate solution added	yellow precipitate

What is X?

- A lithium bromide
- B lithium iodide
- C potassium bromide
- D potassium iodide

21 Where in the Periodic Table is the metallic character of the elements greatest?

	left or right side of a period	at the top or bottom of a group
A	left	bottom
B	left	top
C	right	bottom
D	right	top

22 Which statement about the elements in Group I is correct?

- A Hydrogen is evolved when they react with water.
- B Ions of Group I elements have a  $-1$  charge.
- C Sodium is more reactive than potassium.
- D Solid sodium is a poor electrical conductor.

23 Osmium is a transition element.

Which row gives the expected properties of osmium?

	melting point	density	compounds formed
<b>A</b>	high	high	coloured
<b>B</b>	high	high	white
<b>C</b>	high	low	white
<b>D</b>	low	high	coloured

24 Two statements about noble gases are given.

- 1 Noble gases are reactive, monatomic gases.
- 2 Noble gases all have full outer shells of electrons.

Which is correct?

- A** Both statements are correct and statement 2 explains statement 1.  
**B** Both statements are correct but statement 2 does not explain statement 1.  
**C** Statement 1 is correct but statement 2 is incorrect.  
**D** Statement 2 is correct but statement 1 is incorrect.

25 Some properties of substance X are listed.

- It conducts electricity when molten.
- It has a high melting point.
- It burns in oxygen and the product dissolves in water to give a solution with pH 11.

What is X?

- A** a covalent compound  
**B** a macromolecule  
**C** a metal  
**D** an ionic compound

26 The list shows the order of reactivity of some elements.

K      Na      Ca      Mg      Zn      Fe      (H)      Cu

Which statement about the reactivity of these metals is correct?

- A Copper reacts with steam to form hydrogen gas.
- B Magnesium is more reactive than calcium.
- C Potassium reacts with water to form hydrogen gas.
- D Sodium oxide is reduced by carbon to sodium.

27 Iron is obtained from its ore in a blast furnace and is used to make steel.

Iron obtained from the blast furnace is contaminated with .....1..... .

In order to remove this substance, .....2..... is passed through the molten iron.

.....3..... is also added to remove oxides of phosphorus and silicon which are .....4..... .

Which words complete the sentences about the conversion of iron to steel?

	1	2	3	4
<b>A</b>	carbon	nitrogen	calcium carbonate	acidic
<b>B</b>	carbon	oxygen	calcium oxide	acidic
<b>C</b>	carbon	oxygen	calcium oxide	basic
<b>D</b>	sand	oxygen	calcium oxide	basic

28 Copper is a transition element used to make saucepans.

Which property is **not** correct for copper?

- A good conductor of heat
- B insoluble in water
- C low melting point
- D malleable (can be hammered into shape)

29 The diagram shows an experiment to investigate how paint affects the rusting of iron.

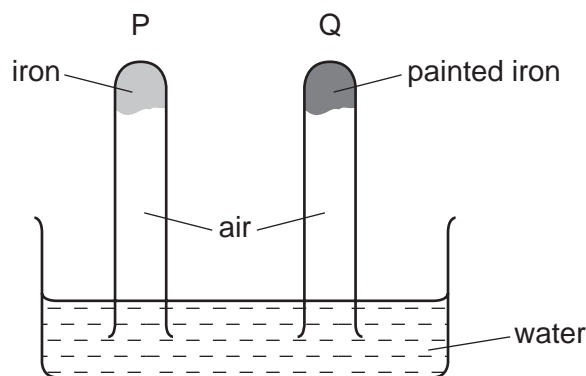

What happens to the water level in tubes P and Q?

	tube P	tube Q
<b>A</b>	falls	rises
<b>B</b>	no change	rises
<b>C</b>	rises	falls
<b>D</b>	rises	no change

30 A new planet has been discovered and its atmosphere has been analysed.

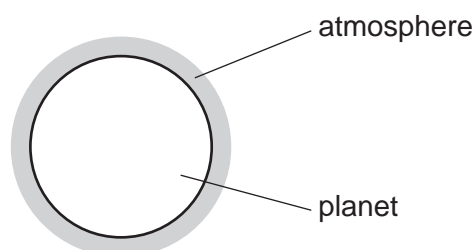

The table shows the composition of its atmosphere.

gas	percentage by volume
carbon dioxide	4
nitrogen	72
oxygen	24

Which gases are present in the atmosphere of the planet in a higher percentage than they are in the Earth's atmosphere?

- A** carbon dioxide and oxygen
- B** carbon dioxide only
- C** nitrogen and oxygen
- D** nitrogen only

31 The following substances can be formed when petrol is burnt in a car engine.

Which substance is the main cause of acid rain?

- A carbon
- B carbon monoxide
- C nitrogen dioxide
- D water

32 Which statement about methane is **not** correct?

- A It is a greenhouse gas.
- B It is an alkene.
- C It is formed by decomposition of vegetation.
- D It is used as a fuel.

33 The formulae of four compounds, W, X Y and Z, are given.

compound	formula
W	$\text{FeSO}_4$
X	$(\text{NH}_4)_3\text{PO}_4$
Y	$\text{KNO}_3$
Z	$\text{NaCl}$

Which mixture of compounds makes a complete fertiliser?

- A W and X      B W and Z      C X and Y      D Y and Z

34 Which process is used to make lime (calcium oxide) from limestone (calcium carbonate)?

- A chromatography
- B electrolysis
- C fractional distillation
- D thermal decomposition

35 The diagram shows the separation of petroleum into fractions.

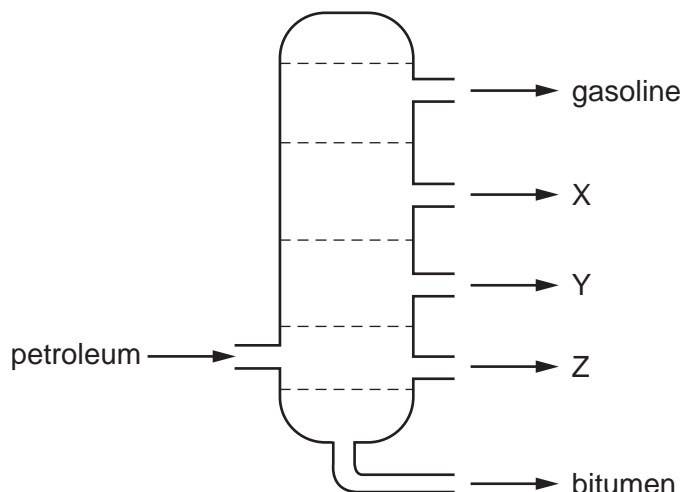

What could X, Y and Z represent?

	X	Y	Z
<b>A</b>	diesel oil	lubricating fraction	paraffin
<b>B</b>	lubricating fraction	diesel oil	paraffin
<b>C</b>	paraffin	lubricating fraction	diesel oil
<b>D</b>	paraffin	diesel oil	lubricating fraction

36 Which compound does **not** belong to the same homologous series as the other three compounds?

- A**  $\text{CH}_3\text{OH}$       **B**  $\text{C}_2\text{H}_5\text{COOH}$       **C**  $\text{C}_2\text{H}_5\text{OH}$       **D**  $\text{C}_7\text{H}_{15}\text{OH}$

37 Which reaction is used as a test for alkenes?

- A** Alkenes burn in air to give carbon dioxide and water.  
**B** Alkenes decolourise aqueous bromine.  
**C** Alkenes form polymers when heated in the presence of a catalyst.  
**D** Alkenes react with steam to form alcohols.

38 Which statement about ethanol is correct?

- A** It burns in air to form ethene and water.  
**B** It is prepared from ethene by fermentation.  
**C** It is prepared from glucose in an addition reaction.  
**D** It is the only product when ethene reacts with steam.

39 Ethene forms an addition polymer as shown.

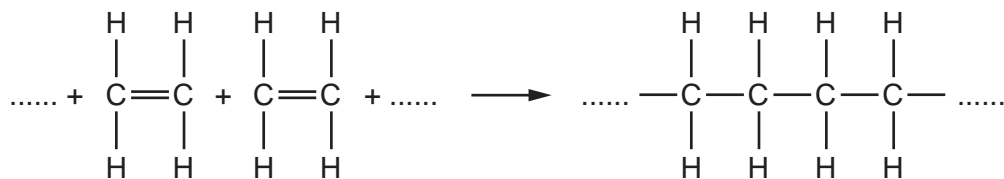

Which terms describe this polymer?

- A a saturated compound called poly(ethane)
  - B a saturated compound called poly(ethene)
  - C an unsaturated compound called poly(ethane)
  - D an unsaturated compound called poly(ethene)
- 40 Liquid W burns completely to give carbon dioxide and water.

Liquid W is a compound containing carbon, hydrogen and oxygen.

A solution of liquid W in water is pH7.

What is liquid W?

- A ethanoic acid
- B ethanol
- C gasoline
- D methane

---

Permission to reproduce items where third-party owned material protected by copyright is included has been sought and cleared where possible. Every reasonable effort has been made by the publisher (UCLES) to trace copyright holders, but if any items requiring clearance have unwittingly been included, the publisher will be pleased to make amends at the earliest possible opportunity.

To avoid the issue of disclosure of answer-related information to candidates, all copyright acknowledgements are reproduced online in the Cambridge International Examinations Copyright Acknowledgements Booklet. This is produced for each series of examinations and is freely available to download at [www.cie.org.uk](http://www.cie.org.uk) after the live examination series.

Cambridge International Examinations is part of the Cambridge Assessment Group. Cambridge Assessment is the brand name of University of Cambridge Local Examinations Syndicate (UCLES), which is itself a department of the University of Cambridge.

## The Periodic Table of Elements

Group																													
I	II	Key										III	IV	V	VI	VII	VIII												
3	4	1	2	3	4	5	6	7	8	9	10	11	12	13	14	15	16	17	18										
Li lithium 7	Be beryllium 9	H hydrogen 1	He helium 4	Scandium 21	Titanium 22	Vanadium 23	Chromium 24	Manganese 25	Iron 26	Cobalt 27	Nickel 28	Copper 29	Zinc 30	Gallium 31	Germanium 32	Arsenic 33	Selenium 34	Bromine 35	Krypton 36										
11 Na sodium 23	12 Mg magnesium 24	Scandium 45	Titanium 48	Vanadium 51	Chromium 52	Manganese 55	Iron 56	Cobalt 59	Nickel 59	Copper 64	Zinc 65	Gallium 70	Germanium 73	Arsenic 75	Selenium 79	Bromine 80	Krypton 84	Xenon 131											
19 K potassium 39	20 Ca calcium 40	Scandium 45	Titanium 48	Vanadium 51	Chromium 52	Manganese 55	Iron 56	Cobalt 59	Nickel 59	Copper 64	Zinc 65	Gallium 70	Germanium 73	Arsenic 75	Selenium 79	Bromine 80	Krypton 84	Xenon 131											
37 Rb rubidium 85	38 Sr strontium 88	Yttrium 89	Zirconium 91	Niobium 93	Molybdenum 96	Technetium —	Ruthenium 101	Rhodium 103	Palladium 106	Silver 108	Cadmium 112	Indium 115	Tin 119	Antimony 122	Tellurium 128	Iodine 127	Xenon 131												
55 Cs caesium 133	56 Ba barium 137	Lanthanoids 57–71	Hafnium 72	Tantalum 73	Tungsten 74	Rhenium 75	Osmium 76	Iridium 77	Platinum 78	Gold 79	Mercury 80	Thallium 81	Lead 82	Bismuth 83	Polonium 84	Astatine 85	Rn radon 86												
87 Fr francium —	88 Ra radium —	Actinoids 89–103	Rutherfordium 104	Dubnium 105	Seaborgium 106	Bohrium 107	Hassium 108	Meitnerium 109	Darmstadtium 110	Roentgenium 111	Copernicium 112	Flerovium 114	Livermorium 116	—	—	—	—												
		lanthanoids																											
57	La lanthanum 139	58	Ce cerium 140	59	Pr praseodymium 141	60	Nd neodymium 144	61	Pm promethium —	62	Sm samarium 150	63	Eu europium 152	64	Gd gadolinium 157	65	Tb terbium 159	66	Dy dysprosium 163	67	Ho holmium 165	68	Er erbium 167	69	Tm thulium 169	70	Yb ytterbium 173	71	Lu lutetium 175
		actinoids																											
89	Ac actinium —	90	Th thorium 232	91	Pa protactinium 231	92	U uranium 238	93	Np neptunium —	94	Pu plutonium —	95	Am americium —	96	Cm curium —	97	Bk berkelium —	98	Cf californium —	99	Es einsteinium —	100	Fm fermium —	101	Md mendelevium —	102	No nobelium —	103	Lr lawrencium —

The volume of one mole of any gas is 24 dm<sup>3</sup> at room temperature and pressure (r.t.p.)