

Centre Number	Candidate Number	Name
---------------	------------------	------

UNIVERSITY OF CAMBRIDGE INTERNATIONAL EXAMINATIONS
International General Certificate of Secondary Education

PHYSICS

0625/06

Paper 6 Alternative to Practical

May/June 2004

1 hour

Candidates answer on the Question Paper.
No Additional Materials are required.

READ THESE INSTRUCTIONS FIRST

Write your Centre number, candidate number and name on all the work you hand in.
Write in dark blue or black pen in the spaces provided on the Question Paper.
You may use a soft pencil for any diagrams, graphs or rough working.
Do not use staples, paper clips, highlighters, glue or correction fluid.

Answer **all** questions.

At the end of the examination, fasten all your work securely together.

The number of marks is given in brackets [] at the end of each question or part question.

If you have been given a label, look at the details. If any details are incorrect or missing, please fill in your correct details in the space given at the top of this page.

Stick your personal label here, if provided.

For Examiner's Use	
1	
2	
3	
4	
5	
Total	

This document consists of **11** printed pages and **1** blank page.



- 1 The IGCSE class is investigating the conduction of electric current through copper sulphate solution. The circuit used is shown in Fig. 1.1.

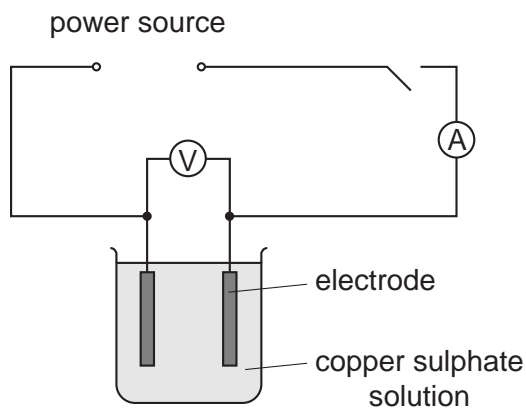

Fig. 1.1

During the experimental work, the students measure the volume of water, the mass of copper sulphate that is dissolved in the water, the current in the solution, the potential difference across the electrodes and the gap between the electrodes.

One set of readings is shown in Figs. 1.2 – 1.6.

- (a) Write down the readings shown. Include appropriate units.

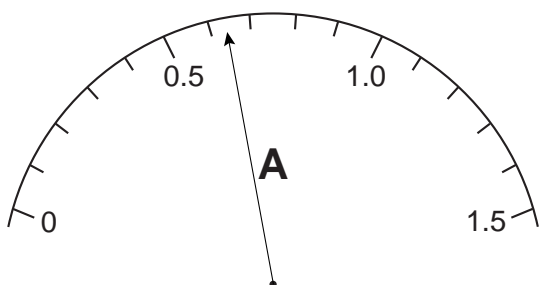

Fig. 1.2

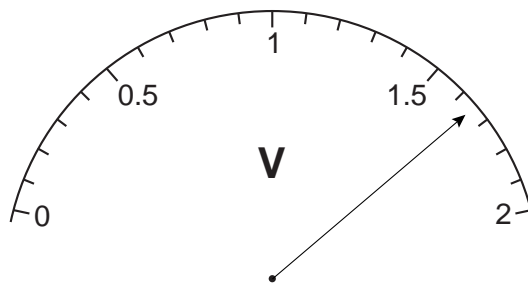

Fig. 1.3

current =

potential difference =

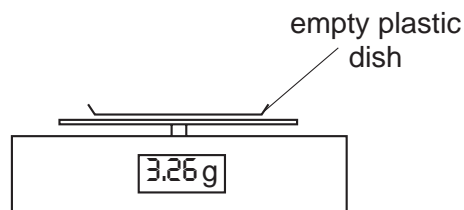
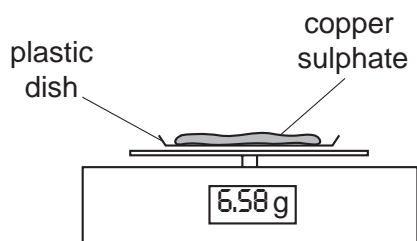

Fig. 1.4

mass of copper sulphate =

3

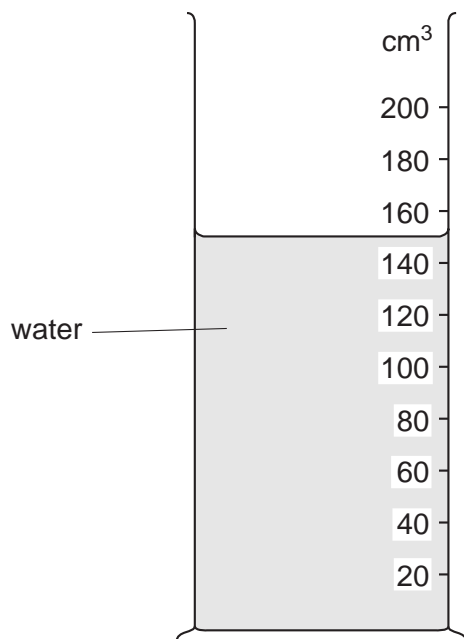

Fig. 1.5

volume of water =

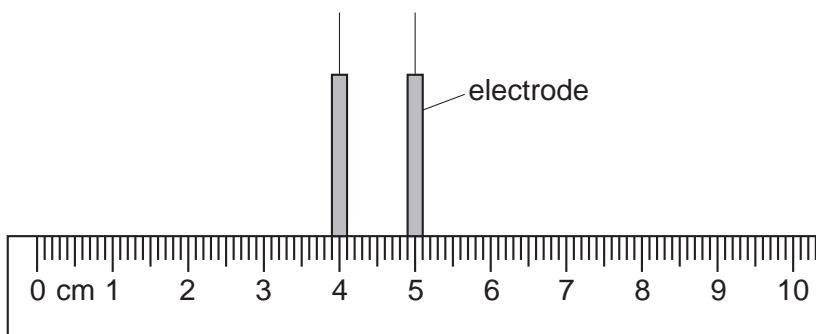

Fig. 1.6

gap between electrodes = [6]

(b) It is not possible to put the rule inside the beaker to measure the gap between the electrodes. Explain how you would overcome this problem.

.....

 [2]

(c) Suggest a variable, which is not measured in Figs. 1.2 – 1.6, that might affect the value of the current.

..... [1]

4

- 2 A student is investigating the oscillation of a metre rule that has one end resting on the laboratory bench. The other end is held above the level of the bench by a spring attached at the 90.0 cm mark. The arrangement is shown in Fig. 2.1.

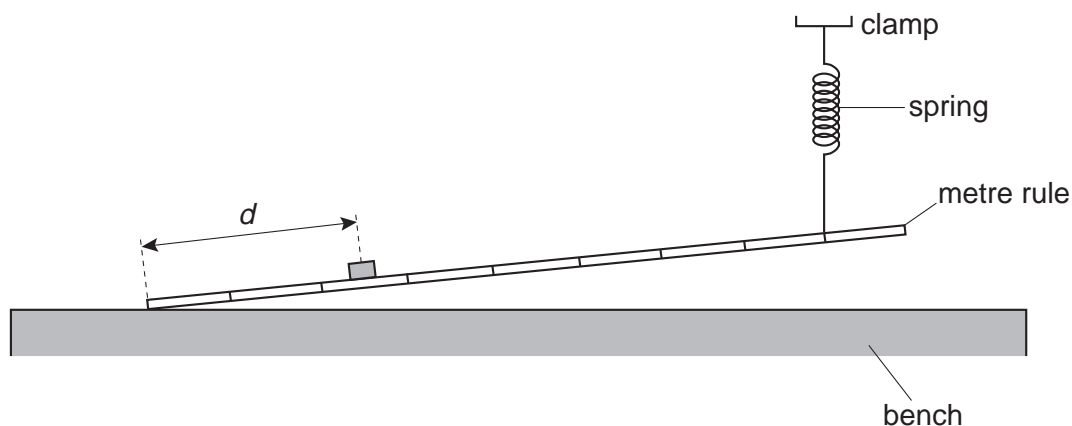

Fig. 2.1

The period of oscillation is changed by moving a 200 g mass to different positions along the rule. The student records the time t taken for 10 oscillations of the end of the rule for each position of the mass. He measures the distance d from the end of the rule to the mark under the centre of the mass. The readings are shown in the table.

d/cm	t/s	T/s
20.0	3.4	
40.0	4.4	
50.0	4.9	
60.0	5.3	
70.0	6.0	
80.0	6.3	

- (a) Calculate the period T for each set of readings and enter the values in the table. [2]

(b) Plot a graph of d/cm (x -axis) against T/s (y -axis). The scale on the x -axis has been started for you. [5]

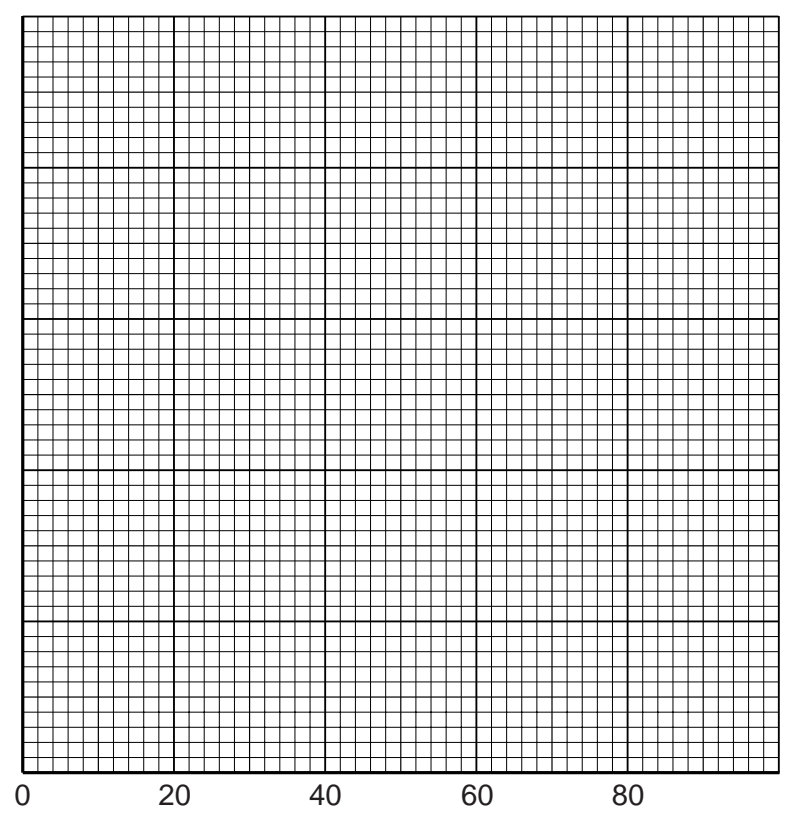

(c) Using the graph, determine the period T when the distance d is 55.0 cm.

$T = \dots\dots\dots$ [2]

(d) The student suggests that T should be proportional to d . State with a reason whether your results support this suggestion.

statement $\dots\dots\dots$

reason $\dots\dots\dots$

$\dots\dots\dots$ [2]

6

- 3 Fig. 3.1 shows the circuit that a student uses to find the resistance of a combination of three lamps.

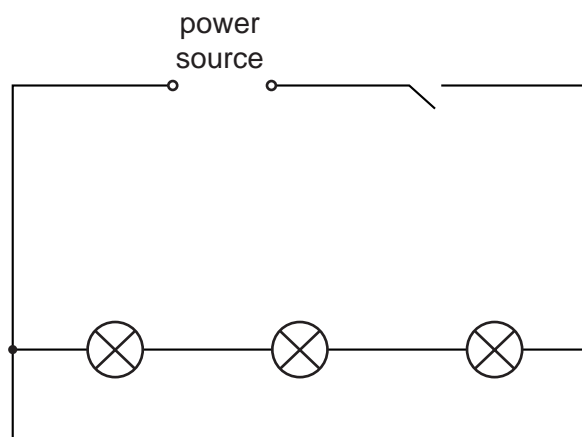

Fig. 3.1

The voltmeter and the ammeter have not been drawn in.

- (a) Complete Fig. 3.1 by drawing in the voltmeter and the ammeter, using conventional symbols. [2]
- (b) The student obtains these readings.

current $I = 0.54 \text{ A}$

potential difference $V = 1.8 \text{ V}$

Calculate the resistance R using the equation $R = \frac{V}{I}$.

$R = \dots\dots\dots$ [2]

7

- (c) The three lamps are now connected in parallel with one another. Draw a circuit diagram of the three lamps connected to the power supply. Include in your circuit diagram
- (i) an ammeter to record the total current through the lamps,
 - (ii) a variable resistor to vary the brightness of all three lamps,
 - (iii) a voltmeter to record the potential difference across the lamps.

[3]

- 4 The IGCSE class carries out an experiment using a convex lens, an illuminated object and a screen. Fig. 4.1 shows the apparatus. A sharp image is obtained on the screen.

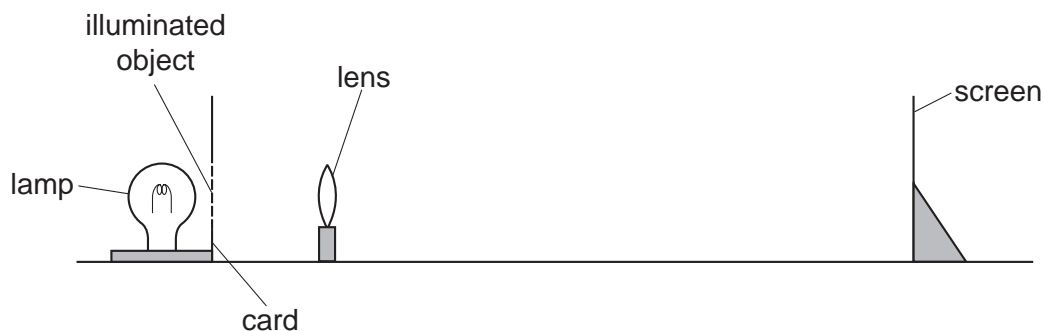

Fig. 4.1

- (a) (i) Use your rule to measure, on Fig. 4.1, the distance x from the illuminated object to the centre of the lens.

$x = \dots\dots\dots$

- (ii) Use your rule to measure, on Fig. 4.1, the distance y from the centre of the lens to the screen.

$y = \dots\dots\dots$

- (iii) Fig. 4.1 shows the apparatus drawn to $1/5$ th of actual size. Calculate the actual distance u between the object and the lens, and the actual distance v between the lens and the screen.

$u = \dots\dots\dots$

$v = \dots\dots\dots$

- (iv) Calculate the magnification m using the equation $m = \frac{v}{u}$.

$m = \dots\dots\dots$

[5]

(b) The illuminated object is triangular in shape, as shown in Fig. 4.2.

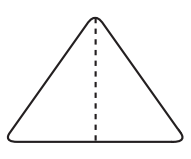

Fig. 4.2

Draw a diagram of the image as it would appear on the screen.

[1]

(c) State two precautions that the IGCSE class should take to obtain experimental readings that are as accurate as possible.

1.
.....

2.
..... [2]

- 5 In a heating experiment, a student takes the temperature of a beaker B containing water at room temperature. Fig. 5.1 shows the thermometer used.

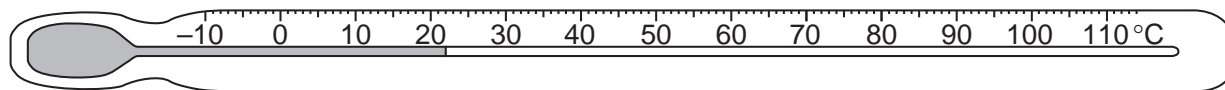

Fig. 5.1

- (a) State the temperature reading shown on the thermometer.

temperature reading = [1]

- (b) The student then transfers a small metal cylinder from beaker A of boiling water to the beaker B of water at room temperature, as shown in Fig. 5.2.

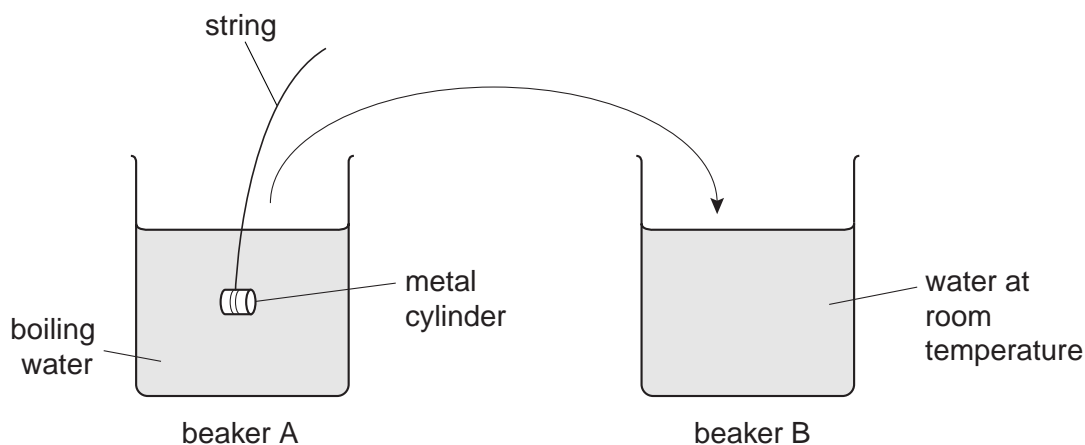

Fig. 5.2

The student assumes that the metal is at a temperature of 100°C when it enters the water in beaker B.

The temperature of the water in beaker B rises to 36°C .

- (i) Calculate the temperature rise of the water in beaker B.

temperature rise =

- (ii) Calculate the temperature fall of the metal cylinder.

temperature fall =

[3]

- (c) The student uses these readings and some other information to calculate the specific heat capacity of the metal.

Why is it important to transfer the metal between the beakers as quickly as possible?

.....

..... [1]

BLANK PAGE

Copyright Acknowledgements

Every reasonable effort has been made to trace all copyright holders. The publishers would be pleased to hear from anyone whose rights we have unwittingly infringed.

University of Cambridge International Examinations is part of the University of Cambridge Local Examinations Syndicate (UCLES), which is itself a department of the University of Cambridge.