

Centre Number	Candidate Number	Name
---------------	------------------	------

CAMBRIDGE INTERNATIONAL EXAMINATIONS
International General Certificate of Secondary Education

PHYSICS

0625/06

Paper 6 Alternative to Practical

May/June 2003

1 hour

Candidates answer on the Question Paper.
No Additional Materials are required.

READ THESE INSTRUCTIONS FIRST

Write your Centre number, candidate number and name on all the work you hand in.
Write in dark blue or black pen in the spaces provided on the Question Paper.
You may use a soft pencil for any diagrams, graphs or rough working.
Do not use staples, paper clips, highlighters, glue or correction fluid.

Answer **all** questions.

At the end of the examination, fasten all your work securely together.

The number of marks is given in brackets [] at the end of each question or part question.

If you have been given a label, look at the details. If any details are incorrect or missing, please fill in your correct details in the space given at the top of this page.

Stick your personal label here, if provided.

For Examiner's Use	
1	
2	
3	
4	
5	
Total	

This document consists of **9** printed pages and **3** blank pages.



2

- 1 A student carried out an experiment to find the spring constant of a steel spring. The apparatus is shown in Fig. 1.1.

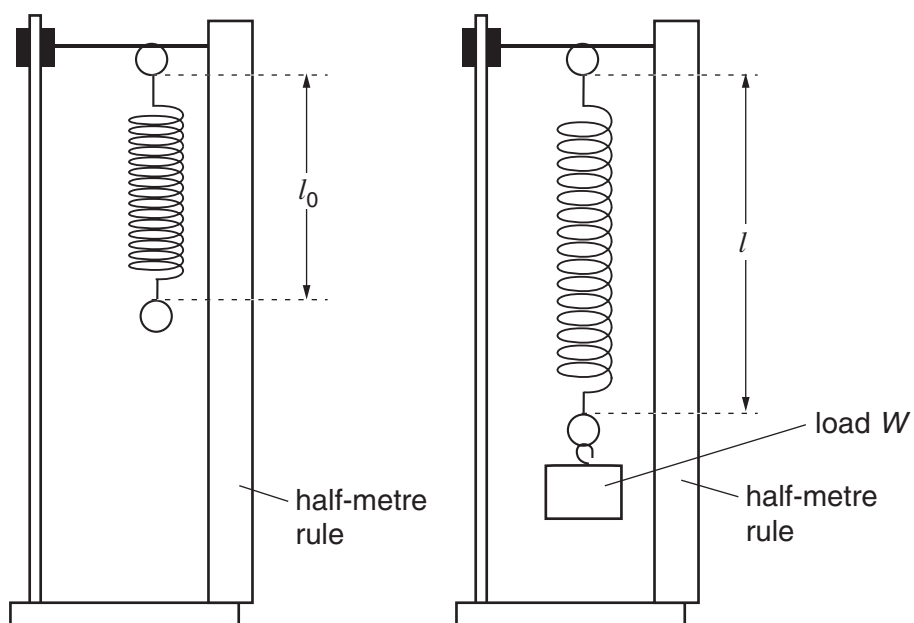

Fig. 1.1

The student recorded the unstretched length l_0 of the spring. Then she added loads W to the spring, recording the new length l each time. The readings are shown in the table below.

W/N	l/mm	e/mm
0	30	
1	32	
2	33	
3	36	
4	39	
5	40	
6	42	

$$l_0 = 30 \text{ mm}$$

- (a) Calculate the extension e of the spring produced by each load, using the equation

$$e = (l - l_0).$$

Record the values of e in the table.

[2]

(b) Plot the graph of e/mm (y -axis) against W/N (x -axis).

[4]

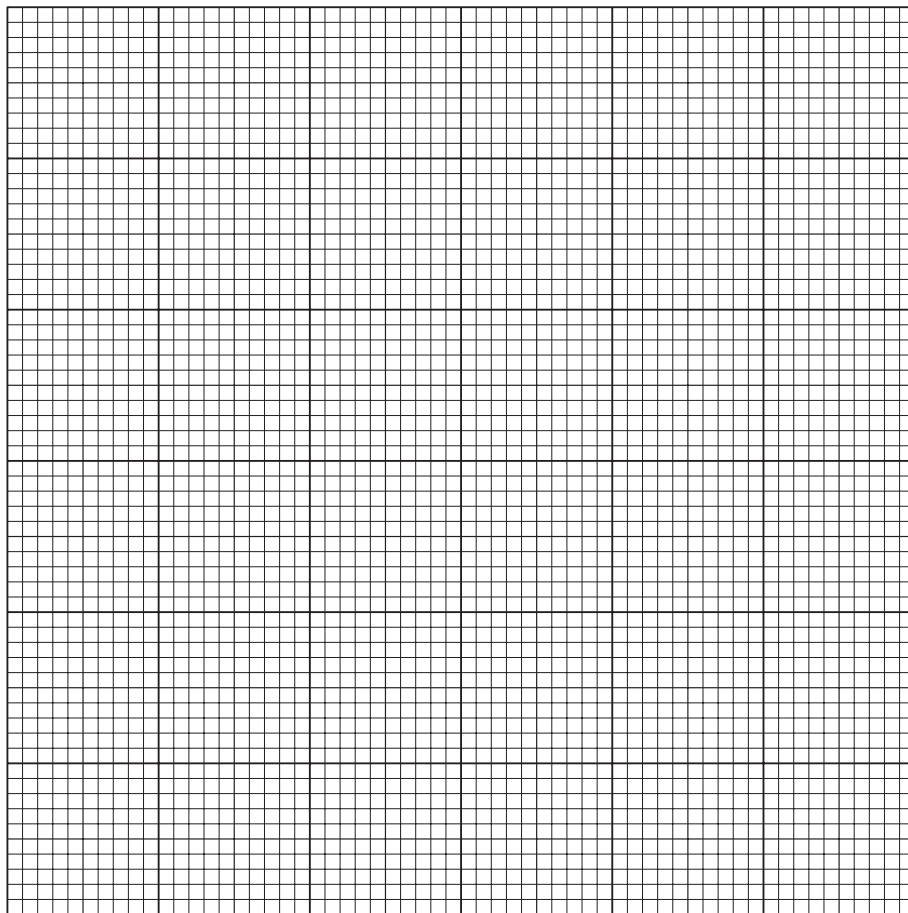

(c) Draw the best-fit straight line for the points you have plotted. Calculate the gradient of the line. Show clearly on the graph how you obtained the necessary information.

gradient =[4]

- 2 An IGCSE student was investigating the passage of red light through a prism. Fig. 2.1 shows the outline of the prism and an incident ray.

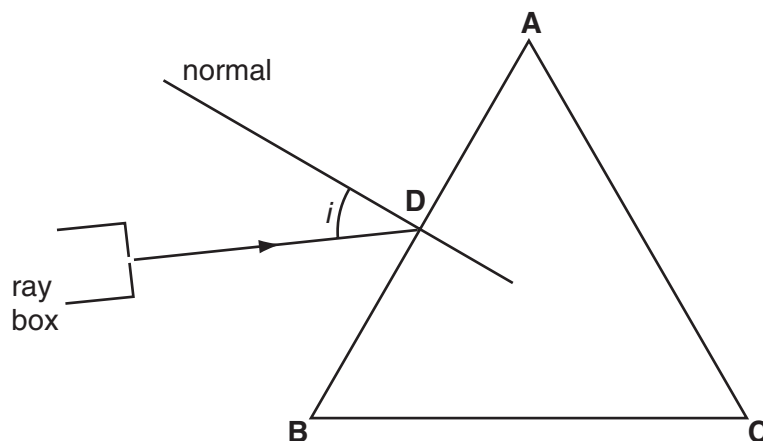

Fig. 2.1

- (a) Measure the angle of incidence i shown in Fig. 2.1.

$i = \dots\dots\dots$ [1]

- (b) The angle of refraction as the ray entered side **AB** of the prism was 22° .

- (i) On Fig. 2.1, draw in the refracted ray from point **D** as accurately as possible.
- (ii) Mark the point **E**, where the ray meets side **AC**. Draw the normal at point **E**.

[4]

- (c) At point **E** the ray came out of the prism with an angle of refraction of 75° . On Fig. 2.1, draw as accurately as possible the ray coming out of the prism. [1]

- (d) Another student used four optics pins to trace the passage of a ray through a prism. Fig. 2.2 shows the prism, the position of the student's eye and the directions of the ray.

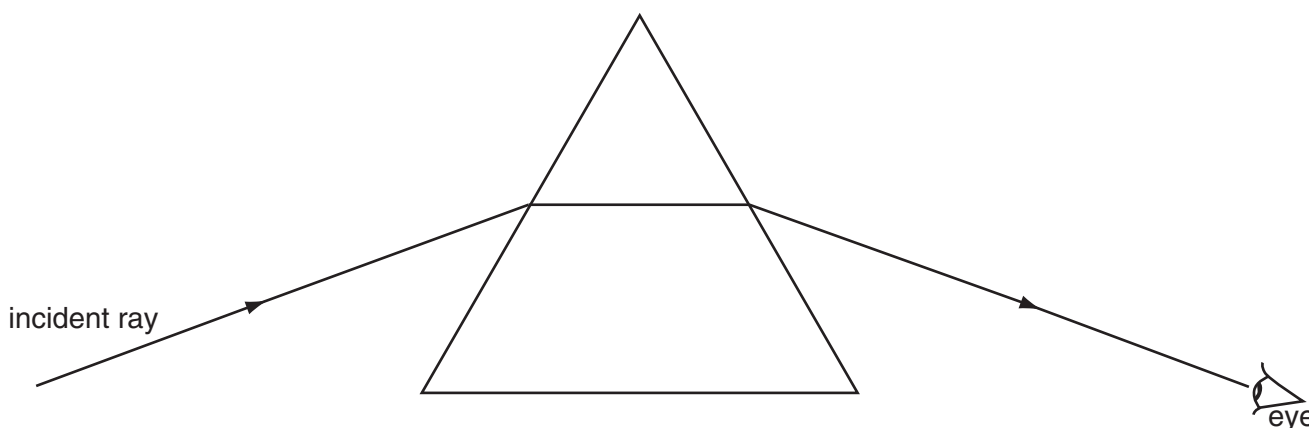

Fig. 2.2

On Fig. 2.2, show positions of the four optics pins, placed to obtain as accurate a result as possible. Mark each position clearly with a cross (X). [2]

- 3 In an electrical experiment, a student set up a circuit to measure current and potential difference. Part of the circuit is shown in Fig. 3.1.

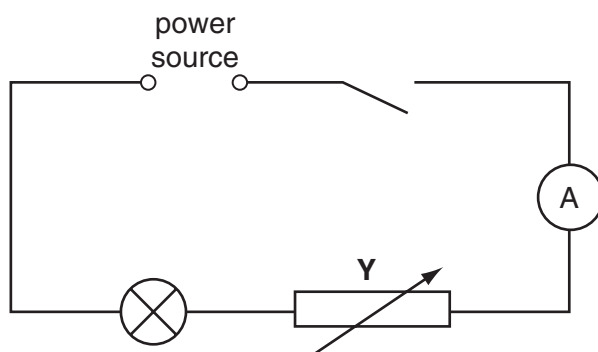

Fig. 3.1

- (a) (i) Complete the circuit diagram by drawing in a voltmeter connected across the lamp.
 (ii) Name the component labelled Y. [2]
- (b) The first reading on the voltmeter was 2.2 V. On the voltmeter face shown in Fig. 3.2, show the position of the pointer giving the reading 2.2 V.

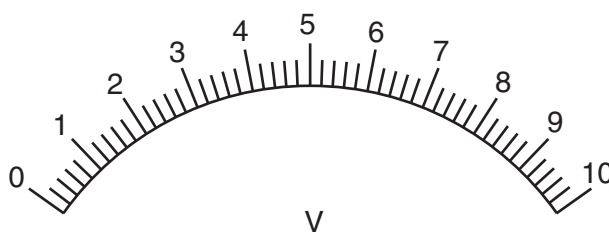

Fig. 3.2

[1]

- (c) The readings of V and I obtained by the student are given in the table below.

$V/$	$I/$	$R/$
2.2	0.36	
4.1	0.62	
6.0	0.86	
7.9	0.98	
9.8	1.20	

- (i) Calculate the resistance R of the lamp filament for each set of V and I readings and write the values in the table. Use the equation

$$R = \frac{V}{I}$$

- (ii) Complete the column headings in the table. [6]

- 4 An IGCSE class watched a demonstration experiment to show that a metal rod expands when heated. The apparatus is shown in Fig. 4.1.

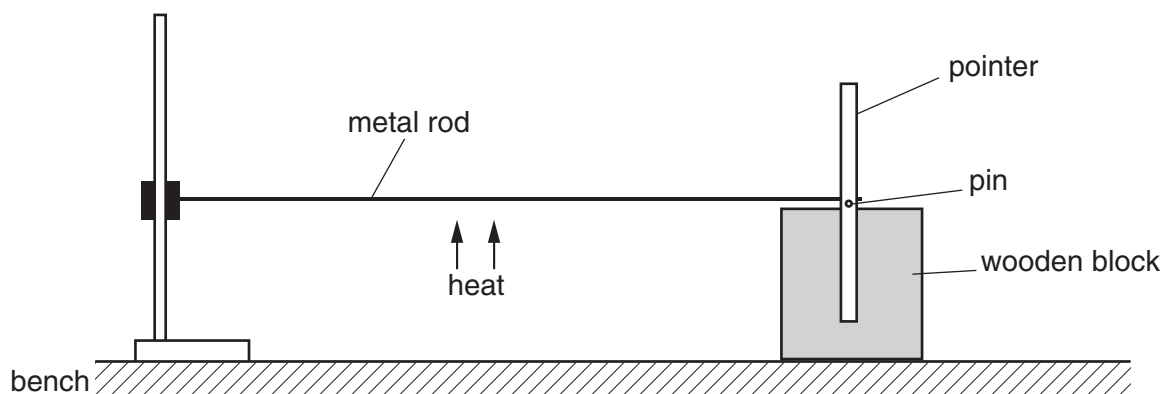

Fig. 4.1

When the rod expands, it rolls the pin which moves the pointer. So a very small expansion moves the pointer far enough to be seen clearly.

- (a) One student wanted to find out how much longer the rod became when heated above room temperature with a Bunsen burner. The rod was 0.750 m long at room temperature.

To find the circumference of the pin, the student wrapped a piece of string 10 times round the pin, marked the string at the beginning and end of the 10 turns, and then measured the length of the string between the marks. Fig. 4.2 shows the string actual size.

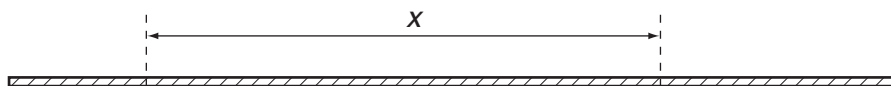

Fig. 4.2

- (i) Use your rule to measure the distance x between the marks on the string on Fig. 4.2.
- $x = \dots\dots\dots$
- (ii) Calculate the circumference c of the pin.

$c = \dots\dots\dots$
[3]

(b) A second student measured the diameter d of the pin using a micrometer screw gauge.

The diameter was 1.20 mm. When the rod was heated, the pointer moved through 90° .

(i) Calculate the circumference c using the equation

$$c = \pi d.$$

$$c = \dots\dots\dots[2]$$

(ii) Use this value of the circumference to calculate the increase e in the length of the rod when heated.

$$e = \dots\dots\dots[1]$$

(iii) Calculate the length l of the heated rod.

$$l = \dots\dots\dots[1]$$

(c) The micrometer screw gauge is a very accurate instrument. Suggest why the string and rule method of finding the circumference, used by the first student, was inaccurate.

.....
[1]

8

- 5 A student was asked to carry out an experiment to compare the insulating properties of cotton wool, cardboard and polystyrene. The apparatus provided was hot water, a thermometer, a stopclock and a copper can with a lid, as shown in Fig. 5.1.

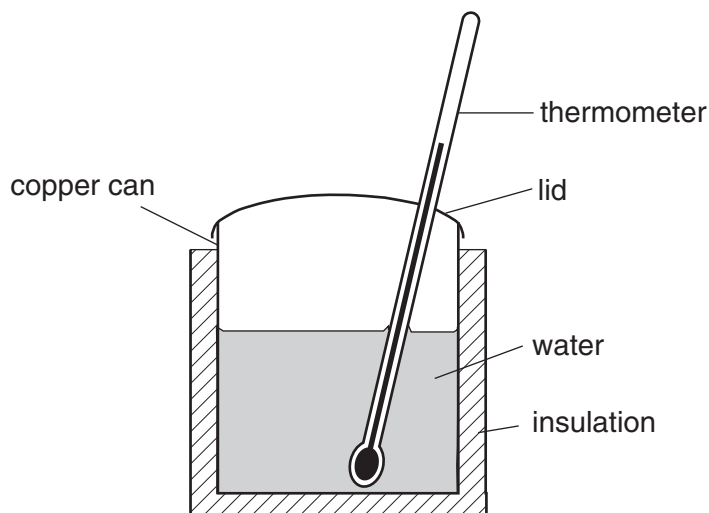

Fig. 5.1

The student wrapped one of the insulators around the can, poured hot water into the can, and then took temperature and time readings as the water cooled. This was then repeated for each insulator. The graph in Fig. 5.2 shows how the student displayed his readings.

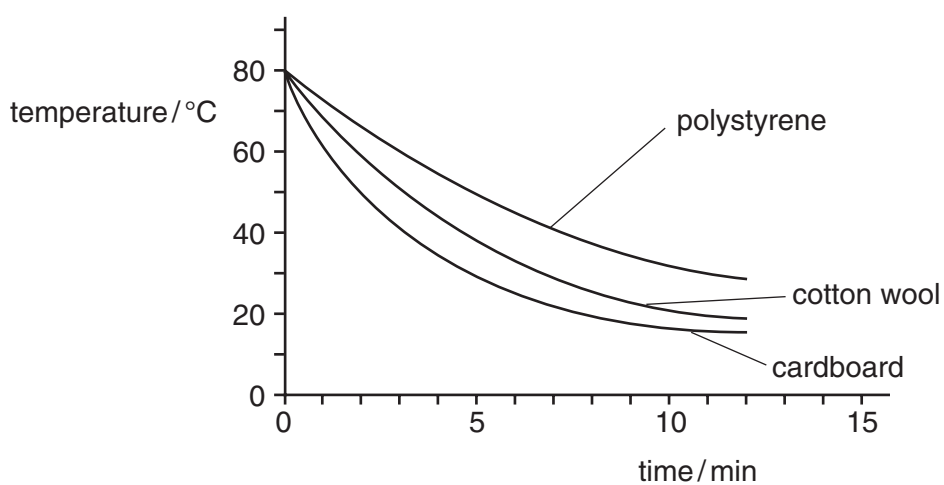

Fig. 5.2

- (a) (i) Using the information on the graph, which material appears to be the best insulator?

.....

- (ii) Justify your answer by referring to the information on the graph.

.....

.....

[2]

(b) In this experiment, it is important to control the variables. Suggest three variables that the student should keep constant for this experiment.

1.

2.

3.

[3]

